



smart Sol nano

Equipment >Advance<

## Assembly and Operating Instructions

Differential temperature controller for solar thermal plants for drinking water heating and heating support

These Assembly and Operating Instructions are an integral part of the product.

- > Read Assembly and Operating Instructions carefully before using the product.
- > Keep them in a safe place during the product's service life.

Translation from the German original edition ©emz 2012 - Subject to modifications.

The contents and representations of these Assembly and Operating Instructions are the intellectual property of emz-Hanauer GmbH & Co.KGaA.

Non-authorized disclosure, reproduction, divulgation or editing of this documentation, as well as exploitation, utilization or publication, are prohibited.

The rights to the word and design marks >emz - smart solutions< and >smart Sol nano< are the exclusive property of emz-Hanauer GmbH & Co.KGaA.

The rights to any cited brands, names or logos are the property of their appropriate developers / of the licensees in question.

Table of contents	Page
Table of Contents	3
Symbols used	4
Important fundamental information	5
Description	6
Dimensions	7
Technical Data	8
Designation of the components	10
Operation of the controller	11
Display	12
Opening the terminal cover	13
Wall-mounting	14
Connection to power supply	15
Hydraulic systems	17
Commissioning mode	21
Automatic mode	23
Operation mode	24
Malfunction	30
Replacement of fuse	34
Professional mode	35
Disassembly/Disposal	44
Warranty and liability	45
Error report	46
Commissioning report	47
EC Declaration of conformity	48
Index	49

# Symbols used

When handling the differential temperature controller **smart Sol nano** and the entire plant, please make sure that the following safety provisions in the Assembly and Operating Instructions are complied with!



## Danger!

Immediate danger for assets, life and limb!



## Important!

Important information compliance with which is essential!



## Note!

Useful information regarding handling of the device and the plant!



# Important fundamental information

These instructions describe installation, commissioning, operation, repair and disassembly of the differential temperature controller **smart Sol nano** for solar thermal plants.

For operation of the entire plant, the technical documentation of all the components used such as solar collectors, boiler, tank, pumps, mixers and valves etc. must be complied with.



## Danger!

Assembly, connection, commissioning, repair and disassembly of the controller may only be performed by a qualified specialist!



The controller is handled by the operator of the entire solar thermal plant, i. e. as a rule by technical non-experts.



## Danger!

The controller by no means replaces the safety components required under plant engineering aspects!



Make sure not to use the controller until you have thoroughly read and understood these Assembly and Operating Instructions and the safety provisions. Comply with all safety provisions and involve a specialist in case of doubt.



## Important!

The fitter installing the controller must inform the plant operator about operation, functioning and the method of action of the **smart Sol nano**!



Keep these Assembly and Operating Instructions and all reference documents so that they are available if required.

When relocating or when selling the device, hand the documents over to your successor.



## Danger!

The device in operation may only be made accessible to adults disposing of appropriate knowledge and experience!



# Description

The differential temperature controller **smart Sol nano** is an independent electronic controller for surface-mounting which is used for the control of solar thermal plants.

The controller is equipped with a robust three-part plastic housing which can only be opened by means of tools (screw driver PH2).

Operation is effected by means of only two control elements; indications appear against a backlit colour display.

Before connection of the electrical system, the controller must be mounted firmly to a perpendicular, robust surface (wall).

For its own supply and the supply of the outputs, the controller must be connected to an electrical energy supply system in accordance with the technical data.

## Note!

The electrical equipment of the device must be installed firmly and connected to the power supply via a disconnector ensuring complete isolation from the power supply according to the erection regulations!

Assembly, connection, commissioning, repair and disassembly of the controller are only admissible in a specialist workshop.

**To ensure correct operation, temperature sensors type Pt 1000 must be used - the sensor design does not affect function.**

Each temperature sensor has two connectors which are equivalent, i. e. interchangeable. Thus, polarity reversal is not an issue.

The sensor lines can be extended up to a length of 100 m, to this effect, a cable cross section of  $2 \times 1.5 \text{ mm}^2$  is recommended.

## Important!

Make sure that only a dry or slightly moistened cloth is used for cleaning and servicing of the housing, the control elements and the display.

The surfaces must never get into contact with cleaning products or solvents - mat, brittle or slightly dissolved plastic parts must be replaced immediately!

A device with damaged housing must not be operated!

# Dimensions

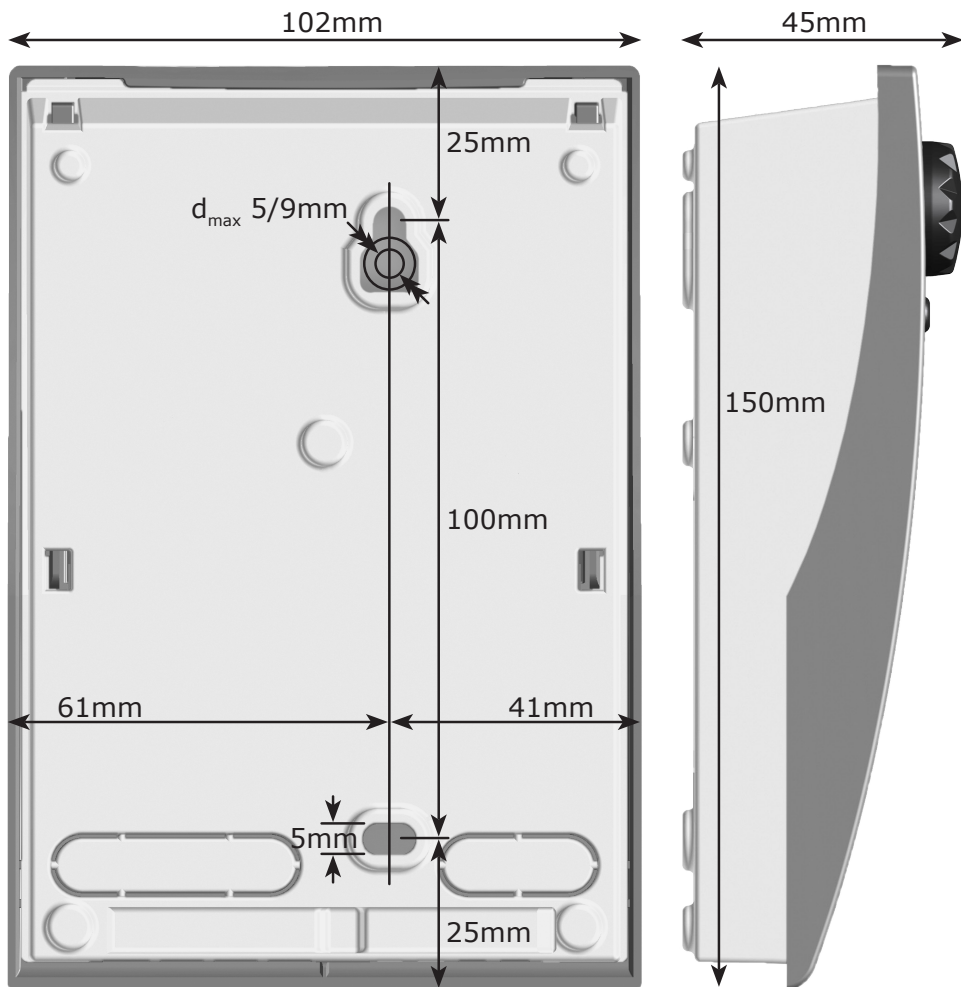

# Technical Data

## Intended Use

The differential temperature controller may be used exclusively as controller for the control of solar thermal plants. It must be operated within the scope of all the specifications described. Installation and set-up of the controller may only be performed by specialists. The fitter must have read and understood the operating manual. The fitter explains all the relevant functions to the operator. For operation, it is essential that the housing is closed and free of damage.

## Scope of supplies

- 1 Differential temperature controller **smart Sol nano**
- 1 Instruction manual

## Differential temperature controller smart Sol nano

Type of mounting	Wall-mounting
Housing	Plastics, in several parts
Mode of operation	Type 1
Type of protection	IP 20
Dimensions Width x Height x Depth [mm]	102 x 150 x 45
Weight [g] Basic version	320
Storage/operating temperature [°C]	0-40, non-condensation
Handling	via rotary encoder and pushbuttons
Display	FSTN monochrome display 45 x 23mm, backlit

## Max. cross sections to be connected

Cable end sleeve:	0.25 to 0.75 mm <sup>2</sup>
Single-wire	0.50 to 1.50 mm <sup>2</sup>
Fine-wired	0.75 to 1.50 mm <sup>2</sup>



## Connection to power supply

Design	3 spring-type terminals PE, N and L
Service voltage [VAC]	230 ±10%
Line frequency [Hz]	50 ±1%
Auxiliary consumption typ. [W]	0,93
Power consumption max. [W]	2.7
Fuse	Micro fuse, type 5 x 20 mm, T2A/250 V
Rated pulse voltage [V]	2500

## Interfaces TS1 / TS2 / TS3 / TS4

Design	2 spring-type terminals each
Inputs TS1 / TS2 / TS3	
Admissible temperature sensor	Pt 1000
Output TS4	PWM output

## Triac output RO1

Design	3 spring-type terminals each, PE, N and L
Output voltage [VAC]	230 ±10%
Output power max. per output [VA]	200
Output current max. per output [A]	1

## Additional switching output REL: 230V - make contact

Design	3 spring-type terminals
Switching voltage max. [V]	253
Switching capacity max. [VA]	230
Switching current max. [A]	1

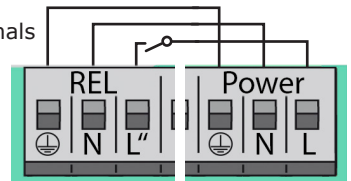

## Important!

For system 2, connection of a relay with potential-free contacts between controller and boiler may be necessary depending on the interface.

For system 3, connection of power relay between controller and electric heating is required.

# Designation of the components

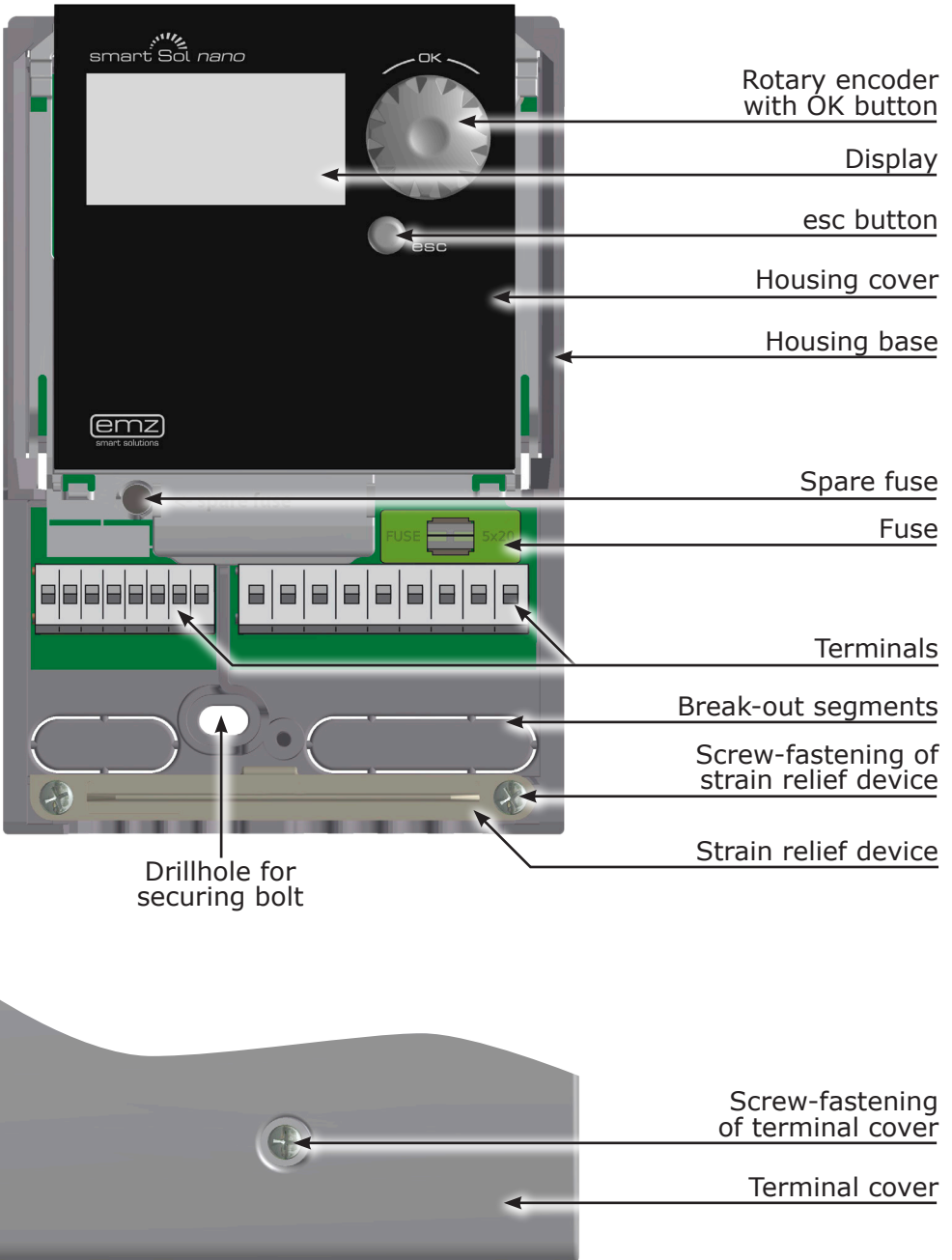

# Operation of the controller

The entire set-up and operation of the differential temperature controller **smart Sol nano** is effected via only two control elements on the device front.

All settings and interrogations are effected via the rotary encoder.

To find a required menu item, turn the rotary encoder to >scroll< through the menu - the selectable option appears on a coloured background on the display.

To confirm the selected menu item, press the rotary encoder. An appropriate submenu is called up, or selection is activated.

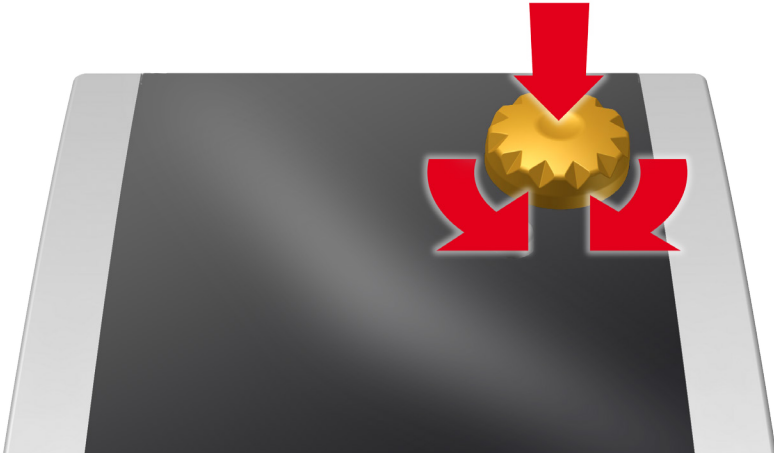

Press the esc button to make the menu return by one level from any subitem.

If no input is made within the preset time (30-255 s), the controller returns automatically to the initial level.

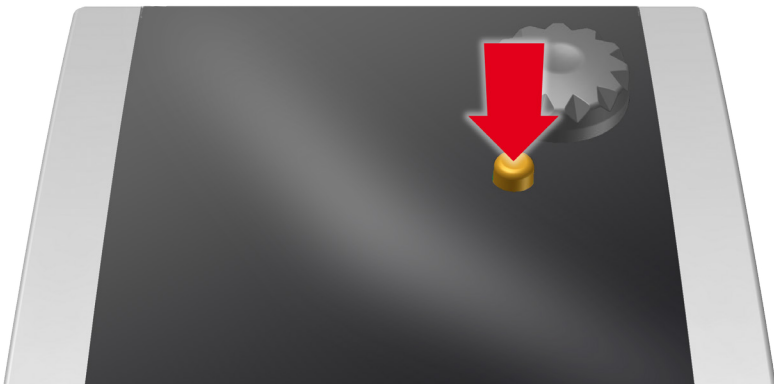

# Display

For indication of the operating mode and for communication in case of set-up, malfunction, modification and evaluation, the differential temperature controller **smart Sol nano** is equipped with a full graphics display which is permanently backlit.

The display is active as long as there is supply voltage on the controller.

After a preset time (30 - 255 s), backlighting is dimmed to 10%.

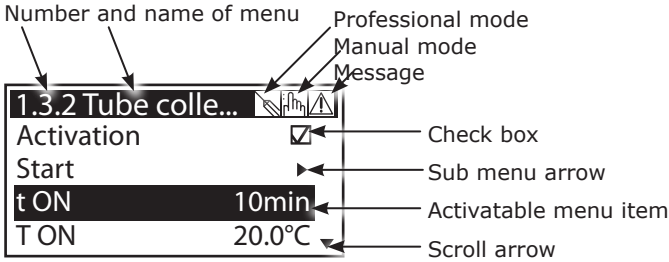

Display elements; example:  
communication screen

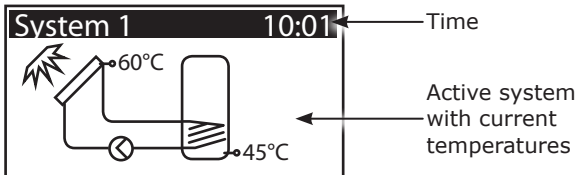

Display elements; example:  
information screen



## Danger!

Mortal danger due to electrocution! Whenever work is performed on the open terminal cover, all poles of the power supply must be disconnected reliably and protected against being switched on again!

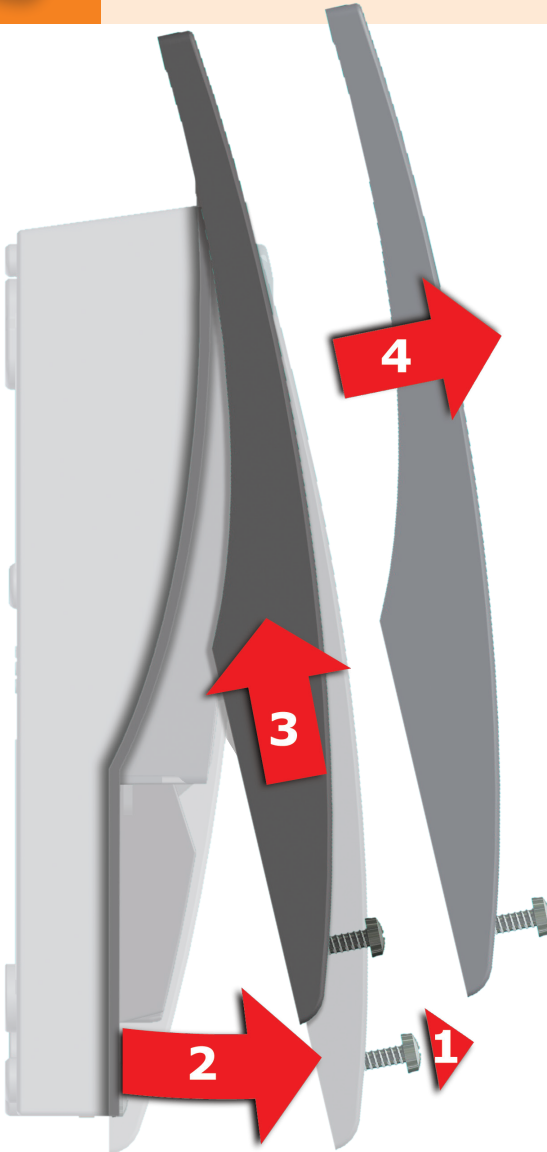

**1** Release the lock screw.

**2** Swing terminal cover forward ...

**3** ... push it upwards ...

**4** ... and remove it.

Store the terminal cover carefully and protect it against damage!

To close the terminal cover, reverse the opening procedure.

## Important!

The device corresponds to protection type IP 20 - make sure the appropriate prerequisites exist on the envisaged place of installation.

Do not use the housing base as drill template.

A device with damaged housing must not be operated!

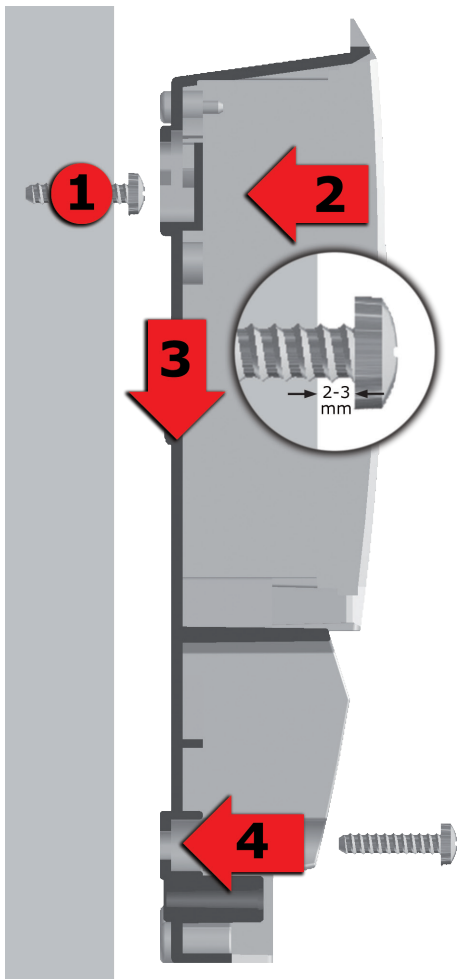

- 1** Fasten the top securing bolt so that a space of 2 to 3 mm is created between the wall and the screw head.
- 2** Move the device so that the upper fastening port is located above the screw head ...
- 3** ... and push it downwards.
- 4** Fasten the lower securing bolt.

If necessary, use dowel pins for wall-mounting!



## Danger!

Mortal danger due to electrocution! Whenever work is performed on the open terminal cover, all poles of the power supply must be disconnected reliably and protected against being switched on again!



The differential temperature controller **smart Sol nano** is connected to the power supply via two groups of spring-type terminals which are visible once the terminal cover is opened.

To introduce the cables, release the two screws on the strain relief device; if necessary, remove the strain relief device.

In case of flush mounting of the cables, the break-out segments in the housing base can be removed carefully and the cables routed through these ports.

The spring-type terminals for the power supply, RO1, REL, TS1, TS2, TS3 and TS4 can accommodate solid wires up to a cross section of 1.5 mm<sup>2</sup>.

Appropriate stranded wires must be preassembled with cable end sleeves.

For the strain relief device function, TS1 to TS4 require cable cross sections of at least 5mm, for Power, RO1 and REL at least 7mm.

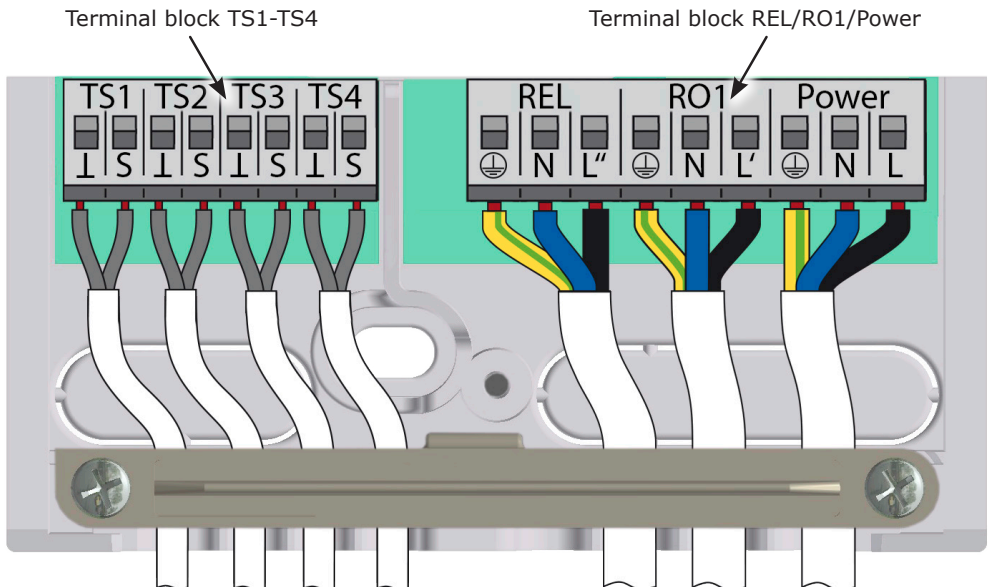

## Boiler control functions

The configuration of the boiler control functions is as shown:

- A Anti-legionellae      Priority 1
- C Auxiliary heating      Priority 2

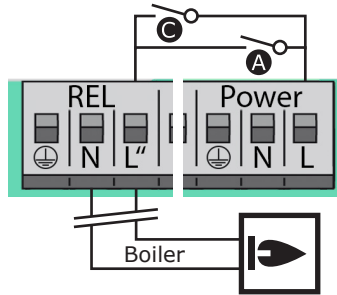

The strain relief device can only ensure solid clamping if the cables are not stripped to a length of over 35 mm.

Insulation of the individual wires must be removed over a length of 9 - 10 mm to ensure safe electric contact in the spring-type terminal.

Stranded wires must be provided with cable end sleeves!

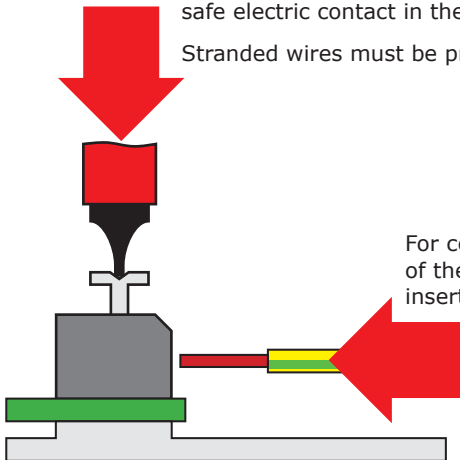
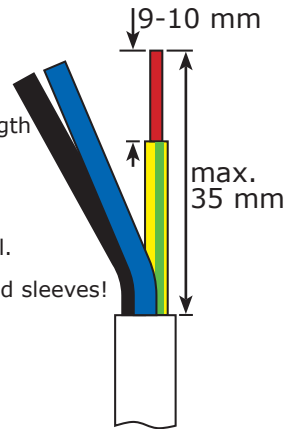

For connection, press the actuation pushbutton of the spring-type terminal using a screwdriver and insert the wire to its stop in the appropriate port.

Release the actuation pushbutton and pull the cable slightly to ensure that it is safely clamped.

## Important!

Before closing the terminal cover, make sure the strain relief device is tightened safely.

Check once more that all cables are in good condition and connected correctly.





## Note!

Define structure and design of the plant already when planning the entire solar thermal system and align the design with the one of the hydraulic systems of the controller!

If you want to complete an existing system or replace the existing controller, please make sure that **smart Sol nano** is compatible with the existing configuration!

The sensors are connected to TS1 to TS4 according to the diagram, devices to be controlled to RO1.

 Temperature probes

 Heating pump

 Solar collector panel

 Boiler, e. g. using fossil fuels/ solid fuels/ heat pump etc.



Warm water /  
buffer tank with  
one heat exchanger



Warm water /  
buffer tank with  
two heat exchangers



Buffer tank with one  
heat exchanger and one  
electric heating rod

# Hydraulic system 1

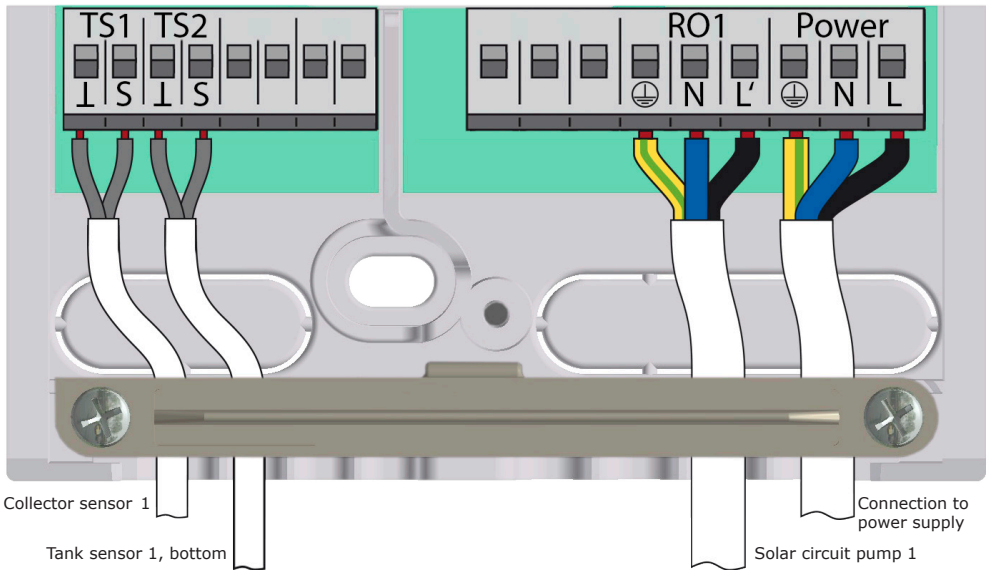
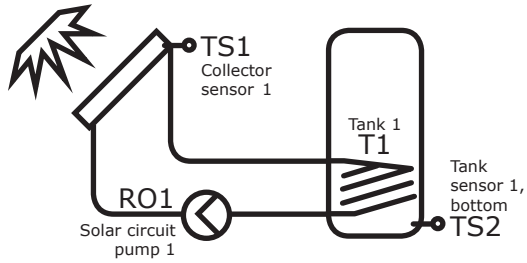

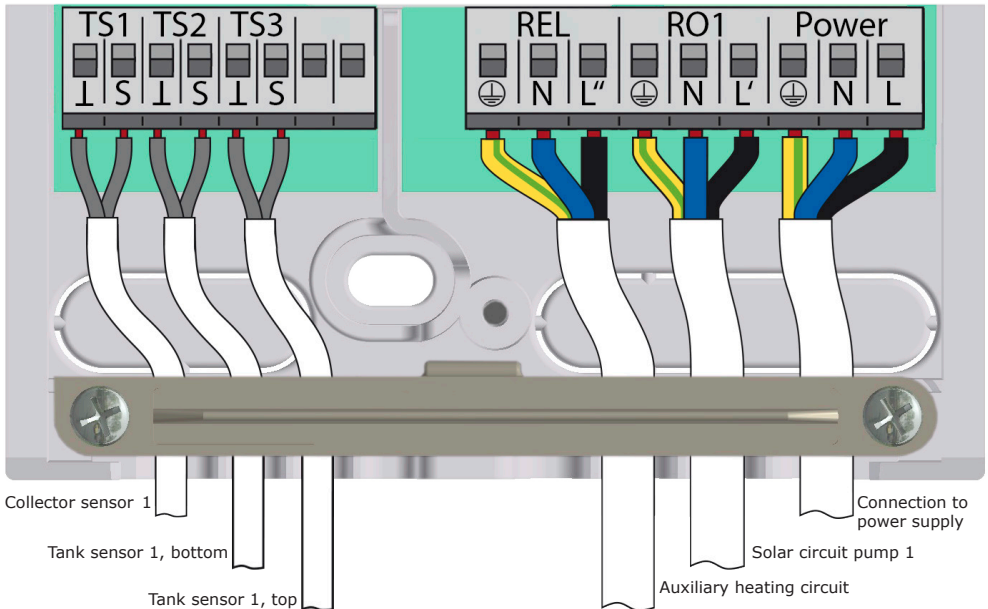
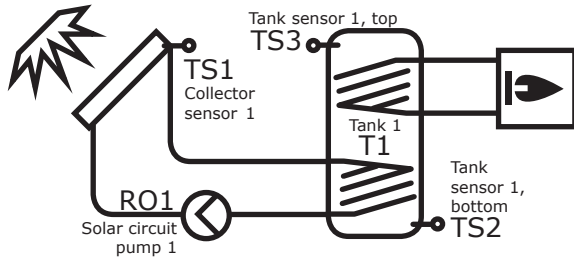

# Hydraulic system 3

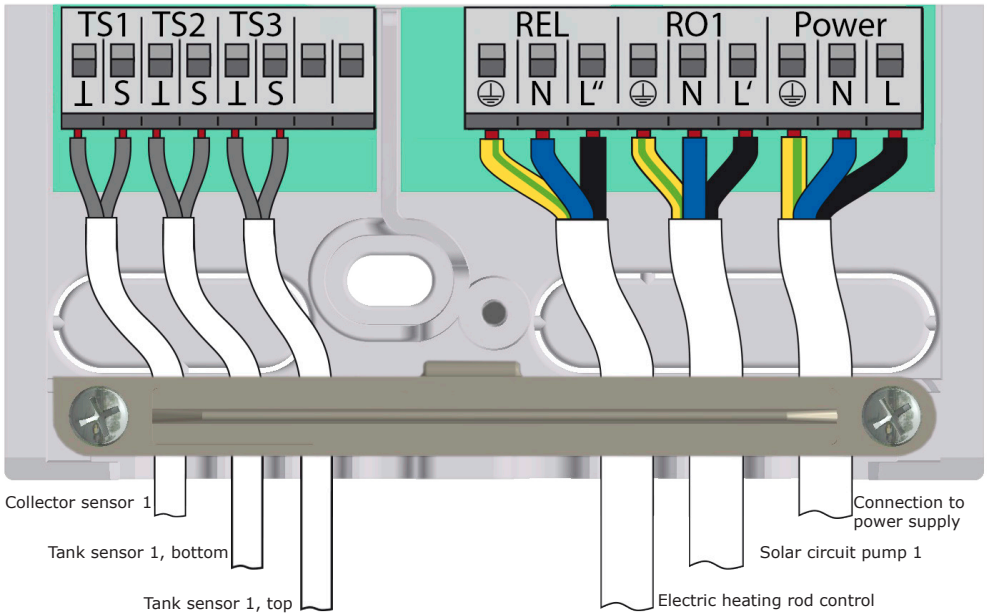
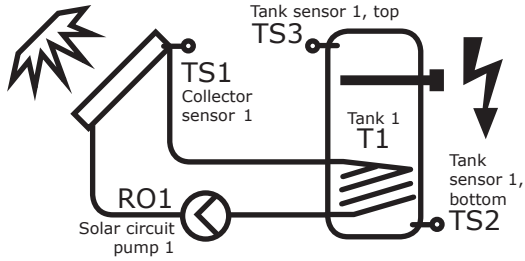

## Important!

For commissioning, the controller must be assembled correctly, all inputs and outputs must be connected and ready for operation, the strain relief device must be screw-fastened and the terminal cover closed!

This is an explanation in terms of an example of commissioning of the differential temperature controller **smart Sol nano**; details vary along with the hydraulic configuration and the software version.

Commissioning is communicated in plain text; the user must make a selection, acknowledge and - if applicable - jump to the next menu item.

The differential temperature controller **smart Sol nano** accompanies you during the entire configuration and interrogates everything it must know for optimum operation.

Now, the power supply of the controller must be switched on - the display screen appears.

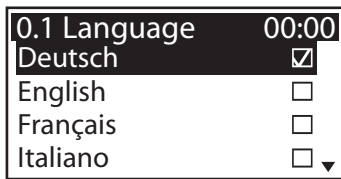

>0.1 Language< appears after a short booting sequence.

Various languages are available in this version of the **smart Sol nano**.

Activate the required version and acknowledge by pressing >Next<.

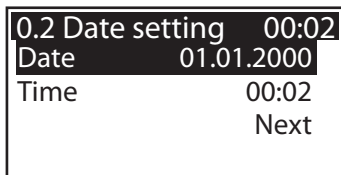

>0.2 Time/date< appears.

Press >OK< - the hour is highlighted.

Turn the rotary encoder until the correct figure appears, and acknowledge via the >OK< button. The controller accepts the value and jumps to the minute setting.

In this way, all values for time and date can be entered, and acknowledged by >Next<.

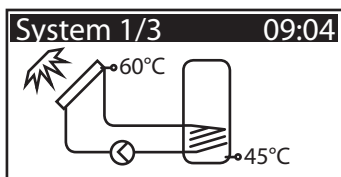

Now, the controller offers the hydraulic systems. By turning the rotary encoder, the required system can be selected (here system 1 of 3 possible ones) and acknowledged via the button >OK<.

# Commissioning mode

>0.7 Checklist< appears.

Here, the submenus >Test outputs< and >HE output< are made available.

Select Test outputs and activate by pressing the >OK< button.

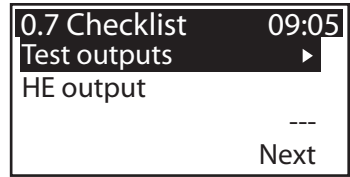

>0.7.1 Test outputs< appears.

Here, the outputs can be activated manually via the >OK< button to test the function of the activated output or of the connected unit.

If not all pumps and valves are working properly, the plant elements in question and the cabling must be verified and repaired.

Acknowledge by pressing >Next<.

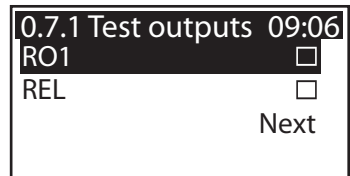

>0.7 Checklist< reappears.

The >HE output< can be defined as >WILO ST25/7 PWM<, >Solar pump analog<, >Solar pump PWM<, >Heater pump analog< or >Heater pump PWM<.

Acknowledge by pressing >Next<.

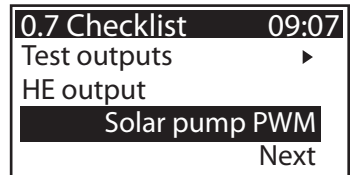

>0.9 End< appears.

By >Next<, the controller changes over to >Automatic mode<.

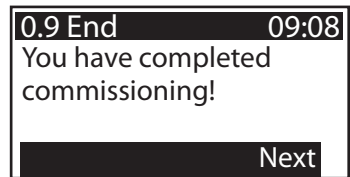

Commissioning is complete.

As of this point, the **smart Sol nano** controls the solar thermal plant automatically.

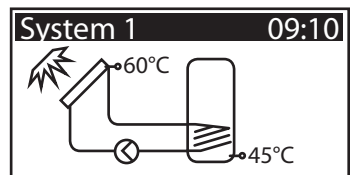

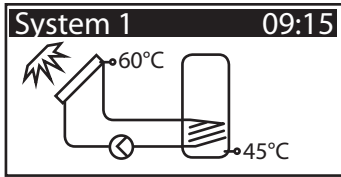

In automatic mode, the screen displays the date, the time and the active hydraulic system.

The current temperature is displayed for each temperature sensor.

The pump activity is displayed on the display as animation.

There is no need for intervention by the fitter or operator.

### Note!

Check the display screen of the **smart Sol nano** on a regular basis to be able to eliminate any malfunctions promptly!

# Operation mode

On the controller, the user can make various settings and obtain information about states and processes.

To this effect, press the button >OK< in automatic mode.

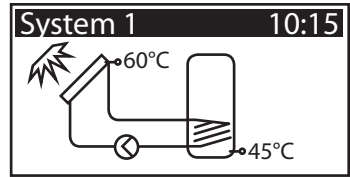

>1 Main menu< appears.

A list of subitems appears

By scrolling ...

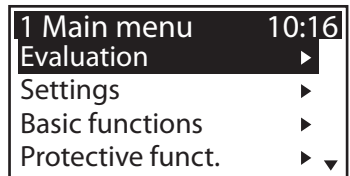

...the lower part of the menu is displayed.

Once the first subitem >Evaluation< is selected, ...

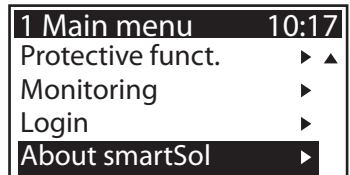

...>1.1 Evaluation< appears.

Another selection level appears.

Once the first subitem >Measured values< is selected, ...

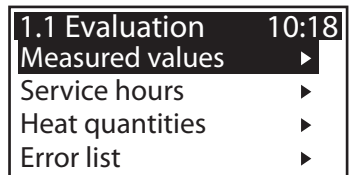

...>1.1.1 Measured val...< appears.

Here, the temperatures and dates concerning the controller are displayed.

If additional tank sensors have been defined on commissioning, these measurands also appear here.

Return to >1.1 Evaluation<.

Once the second subitem >Service hours< is selected, ...

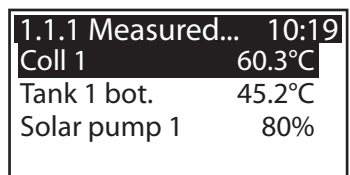



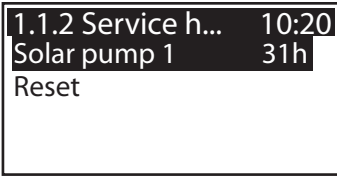

...>1.1.2 Service hours< appears.

The operating time of the activated plant components is displayed in hours. By actuating the menu item >Reset<, all counters are reset to zero.

The values are saved once per day, so that one day max. is „lost“ in case of failure of the power supply.

Return to >1.1 Evaluation<.

Continue with >Heat quantities<.

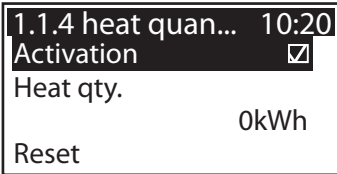

>1.1.4 Heat quantities< appears.

Activation starts a counter which determines the heat yield of the solar plant. Press >Reset< to reset the counter to 0.

Return to >1.1 Evaluation<. Continue with >Error list<.

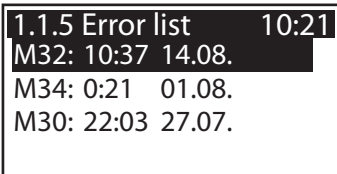

>1.1.5 Error list< appears.

Here, a table of the last errors occurred appears for information.

By selecting a fault ...

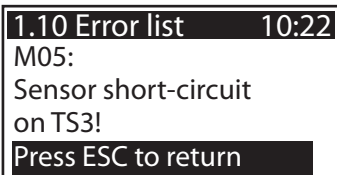

... the error message appears in plain text.

If necessary, take the appropriate measures.

Return to >1 Main menu<. Continue with >Settings<.

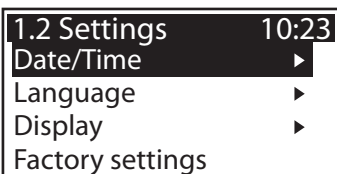

>1.2 Settings< appears.

Another selection level appears.

Once the first subitem >Date/Time< is selected, ...

...>1.2.1 Date settings< appears.

Here, date and time can be set in case of deviation or an extended period of deenergizing.

Select the subitem >Date< or >Time< by pressing >OK<.

1.2.1 Date setting 10:24	
Date	17.08.2012
Time	10:24

One group of figures each is activated and can be varied via the rotary encoder; whenever >OK< is pressed, the activation jumps to the next group.

Return to >1.2 Settings<. Continue with >Language<.

1.2.1 Date setting 10:24	
Date	17.08.2012
Time	10:24

>1.2.2 Language< appears.

Here, the user can change over to another available language.

Continue with >Display<.

1.2.2 Language 10:25	
Deutsch	<input checked="" type="checkbox"/>
English	<input type="checkbox"/>
Français	<input type="checkbox"/>
Italiano	<input type="checkbox"/>

>1.2.7 Display< appears.

>Contrast< serves to adjust the contrast of the display in steps of 1% from 70% to 100%.

>Blanking time< is used to determine the time after which, in case of inactivity, backlighting is switched off. Adjustable in the range from 30 to 255 seconds.

Return to >1.2 Settings<.

1.2.7 Display 10:27	
Contrast	80%
Blanking time	180s

The last menu item is >Factory settings<.

By selecting and pressing the button >OK<, followed by >esc<, the preset values are deleted and replaced by the factory settings.

Return to >1 Main menu<.

Continue with >Basic functions<.

1.2 Settings 10:28	
Activate factory settings?	
Yes	No

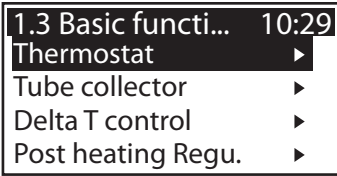

>1.3 Basic functions< appears.  
 Another selection level appears.  
 Once the first subitem >Thermostat< is selected, ...

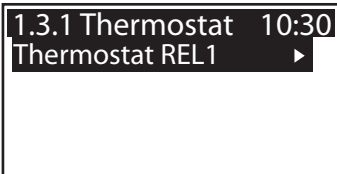

...>1.3.1 Thermostat< appears.  
 The controller's free outputs can be used as thermostats for various applications.  
 In professional mode, presettings must be made to this effect - your fitter will explain the appropriate function to you, if necessary.  
 By selecting a subitem ...



...the appropriate activation screen is displayed.  
 Return to >1.3 Basic functions<.  
 Continue with >Tube collector<.

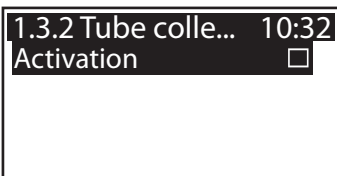

>1.3.2 Tube collectors< appears.  
 This option is to be activated in case vacuum tube collectors are used.  
 Return to >1.3 Basic functions<.  
 Continue with >Delta T control<.

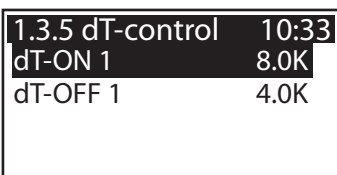

>1.3.5 dT control< appears.  
 Here, parameters of the controller can be changed.  
 The factory settings of the **smart Sol nano** can be used for almost all plants.  
 Ask a fitter before making changes at this point.  
 Return to >1.3 Basic functions<.  
 Continue with >Post heating Regu.<.

>1.3.10 Post hea...< appears.

The auxiliary heating control reacts to the values of the upper tank sensor. In case of values below >T-charge< minus the hysteresis, the control activates the auxiliary heating via the boiler. Once the set value is reached the auxiliary heating process is terminated.

Continue with >Protective functions<.

1.3.10 Post hea...	10:34
Ref. temp.	45.0°C
Hysteresis	10.0K

>1.5 Protective funct.< appears.

Another selection level appears.

Continue with >Tank cooling<.

1.5 Protective f...	10:35
Tank cooling	▶

>1.5.5 Cooling funct.< appears.

This option must be activated if, during a heat wave, the heat input exceeds the energy withdrawal.

In this case, the controller cools the tank via the collectors, e. g. at night.

Return to >1 Main menu<. Continue with >Monitoring<.

1.5.5 Cooling fu...	10:36
Activation	<input type="checkbox"/>

>1.6 Monitoring< appears.

Here, the error list can be called up. The required information appears on the display.

Return to >1 Main menu<. Continue with >Login<.

1.6 Monitoring	10:37
Error list	▶

>1.7 Login< appears.

Here, the fitter can enter his/her access code to perform further settings and changes.

Return to >1 Main menu<.

Continue with >About **smart Sol**<.

1.7 Login	10:38
Access code	0

1.9 About		10:39
smartSol		
SW Version	5.01	
HW Version	3.00	▼

>1.9 About< appears.

Here, the software and hardware version of the controller, the serial number and the date of commissioning appear.

This information is required for repairs and for version management.

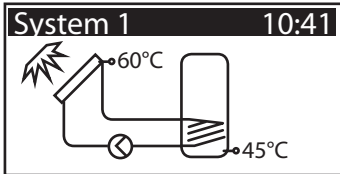

If no entry is made within the preset time (30 - 255 s) on the **smart Sol nano**, the display returns to >System<.

To return there, you can also push the button >esc<.

# Malfunction

The screen on top right shows the >Attention< symbol which points out a notification or an operating malfunction.

Select via >OK<.

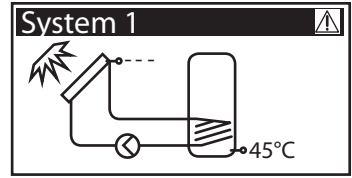

If >Safety function< appears in the display, this is a message, no malfunction.

In this case, there is no deficiency, but limits have been exceeded.

The controller indicates that a protective function has been triggered.

The message is only active until normal operation has been restored.

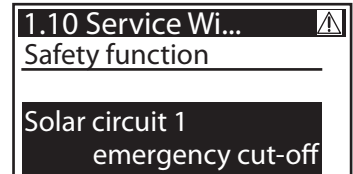

## Note!

If a malfunction message appears in the display, the operator can define the possible causes by means of the Service Wizard so that he/she can provide the fitter with precise information.

The differential temperature controller **smart Sol nano** communicates malfunction processes in plain text. The Service Wizard indicates the possible causes of malfunctions on the basis of the detected symptoms and thus supports immediate and comfortable detection of deficiencies. There may be various deficiencies in a solar thermal system, which require a wide variety of approaches. The controller communicates every step to the operator or fitter via the screen, so that there is no need to describe all malfunctions in detail in this operating manual.

Here, a malfunction message with troubleshooting process is presented as an example.

## Danger!

Mortal danger due to electrocution!  
For troubleshooting on the plant, disconnect all poles of the power supply reliably and protect it them against being switched on again!

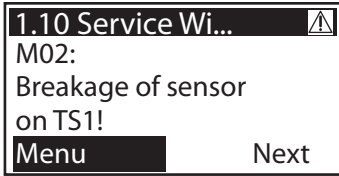

>1.10 Service Wizard< appears.

The malfunction appears in plan text - here:

>M02: Breakage of sensor on TS1!<.

If an analysis/repair is not required at present, press >Menu< to return to the main menu.



The Service Wizard helps detect possible causes of malfunctions.

Acknowledge by pressing >Next<.

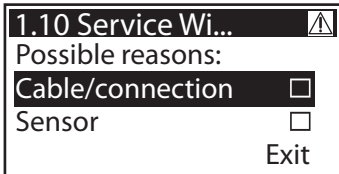

For this malfunction, the following causes are assumed: >Cable/connection< or >Sensor< - select the first menu item and confirm by pressing >OK<.

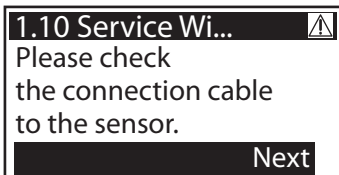

The controller here provides the troubleshooting instruction to check the connection cable.

Perform the measure in accordance with the recommendation.

Acknowledge by pressing >Next<.

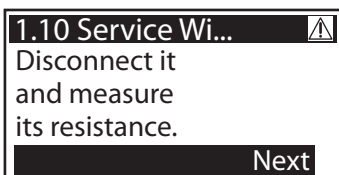

More detailed instructions are available if required.

Acknowledge by pressing >Next<.

The troubleshooting result is interrogated.

Continue via >Yes< for the case that the malfunction has been determined.

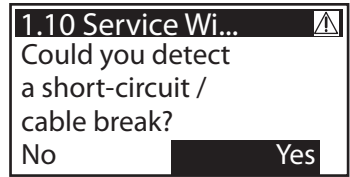

Repair information appears.

Perform the appropriate repair work.

Exit the >Service Wizard< by pressing >Exit<.



If the cause of the malfunction has not yet been determined, troubleshooting can be continued.

Continue with >No<.

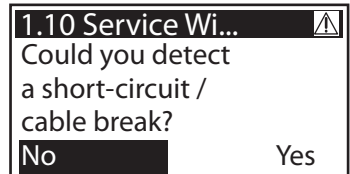

Select all the sources of malfunctions listed, and confirm via >OK<.



Appropriate instructions appear for each source of faults.

Perform the measure in accordance with the recommendation.

Continue with >Explanation<.







A part of the information and instructions may be provided in close detail, so that ...

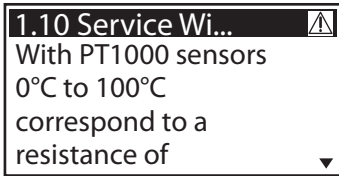

...the texts...

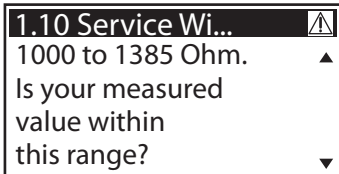

... may well take several screens.

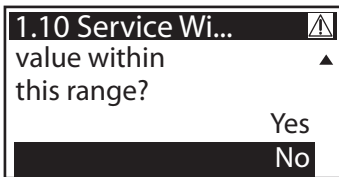

After description of the troubleshooting measure, the result determined by you is interrogated...

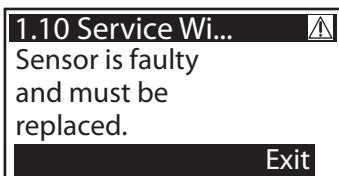

... and the appropriate logical conclusion is made, the repair work displayed.

After elimination of the malfunction, the plant screen without the >Attention< symbol appears again on the display, automatic mode is continued.

# Replacement of fuse



## Danger!

Mortal danger due to electrocution! Before opening the terminal cover, disconnect the power supply reliably!

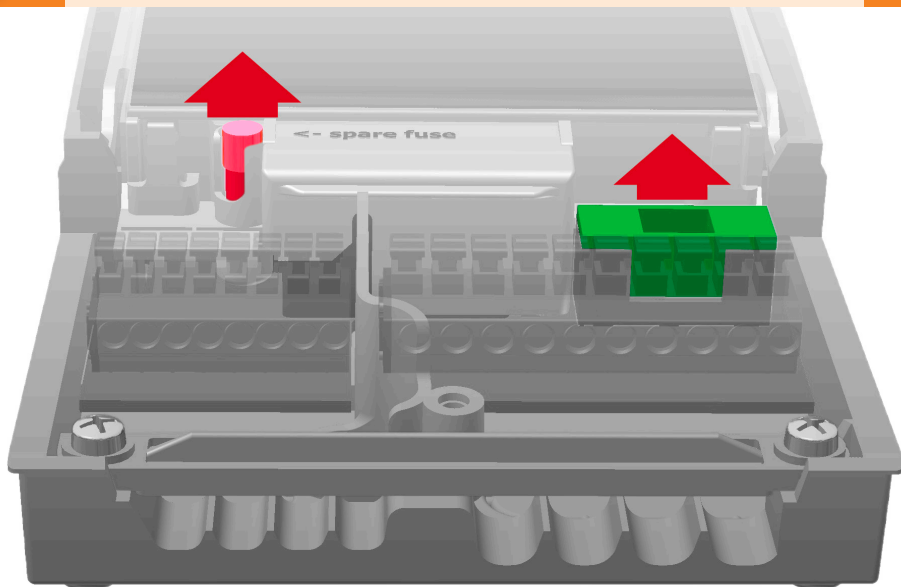

To remove the device fuse, open the terminal cover. Above the right-hand group of terminals, the fuse base and a spare fuse are located. Pull the upper part of the support and the spare part out. The fuse link is clamped in the formed piece and is removed together with the plastic holder.



Now, push the micro-fuse laterally out of its holder. The fuse link is installed by reversing the above order. Make sure to procure yourself immediately a new spare fuse!



## Danger!

Risk of fire due to overload or short-circuit!  
Only use fuse links type 5 x 20 mm, T2A!



## Important!

In professional mode, settings are made which require detailed knowledge of the heating and solar plant. Moreover, solid specialist knowledge regarding control engineering, hydraulics and solar thermal water heating is required!

If a single parameter is changed, this may affect the safety, function and efficiency of the entire plant!

Leave the settings in professional mode to a specialist workshop, the fitter or heating installer!

Modifications by non-experts tend to result in damage to the plant, rather than to an improvement of its efficiency!

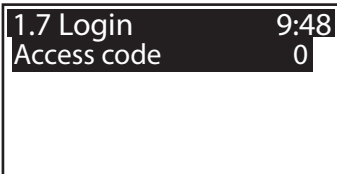

To enter the professional mode, select >1.7 Login< from the main menu, activate and ...

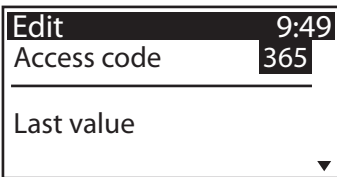

... enter the access code.

The access code to professional mode is >365<.

The fact that the fitter must be available for his/her customers on 365 days per year may serve as a mnemonic trick.

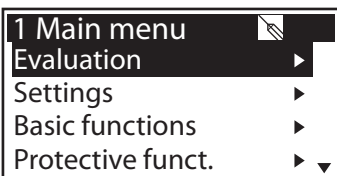

After having returned to >1 Main menu<, the screen shows a list of subitems as in operation mode.

In menu item >1.1 Evaluation<, enhanced setting options for the operation mode are only available in subitem >Heat quantity<.

Continue with >Heat quantities<.



Here, precise settings must be made to enable the controller to set up the heat quantity balance as precisely as possible.

Continue to scroll.

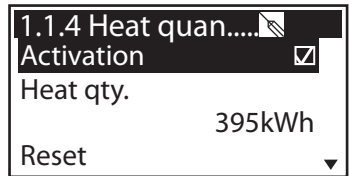

In addition to the operation mode's functions, the sensors in the return and supply lines are assigned.

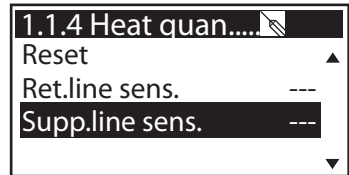

The filling can be defined as water, Tyfocor, propylene glycol or ethylene glycol.

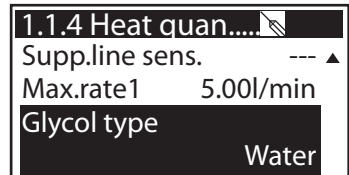

The following items appear under >1.2. Settings< next to the operation mode menus:

- >Temp. limitation<
- >Max.temp.shutoff<
- >Min. temperature<

Call up menu item >Temp. limitation<.

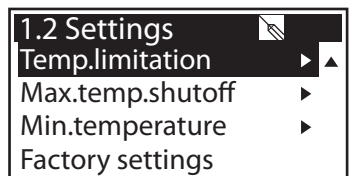

1.2.3 Temp.limit...	
Hyst	5.0K
T limit 1	60.0°C
If T-limit > 60°, anti-scalding protection must be installed	

If the temperature in tank 1 exceeds the value >T limit 1< the solar circuit pump is switched off unconditionally. The pump is not switched on again until the actual temperature falls below the value >T limit< by the hysteresis >Hyst<.

Example: T limit = 60°C minus Hyst = 5K  
=> Reclosing temperature 55°C.

Continue via the menu item >Max.temp.shutoff<.

1.2.5 Max.temp...	
T-max tank 1	59.0°C

Maximum temperature of the tank 1, to avoid excessively hot water in the tank; the tank in question is only charged to its >T max<.

In case of collector overheating, the tank can be charged up to >T-limit<.

Continue via the menu item >Min. temperature<.

1.2.6 Min.tempe...	
Activation	<input type="checkbox"/>
T min Coll.1	20.0°C
Hyst. Coll.1	2.0K

To increase efficiency on charging the tanks, the minimum temperature to be present at the collector in question is entered via >T min. Coll<.

The relevant hysteresis value represents the difference between the switch-ON and switch-OFF temperature.

Return to >Main menu<. Continue with >Basic functions<.

1.3 Basic functi...	
Thermostat	▶
Output parameter	▶
Tube collector	▶
Collector cooling	▶▼

The following items appear under >1.3. Basic functions< next to the operation mode menus:

- >Thermostat<
- >Output parameter<
- >Collector cooling< ...

1.3 Basic functi...	
Collector cooling	▶▲
Commissioning	▶
Delta T control	▶
Post heating Regu.	▶

... and enhanced menus regarding the

- >Delta T control<
- >Fixed T control<

Call up the menu item >Thermostat<.

If outputs on the controller are not assigned, these channels can be used as thermostats.

Perform activation.

As start signal, the timer, timer-thermostat or temperature-thermostat thereof can be set.

Continue to scroll.

1.3.1 Thermost...	
Activation	<input type="checkbox"/>
Start	Timer,thermostat
Sensor	TS1 ▼

Select sensor, output and switching temperatures.

Continue to scroll.

1.3.1 Thermost...	
Sensor	TS1 ▲
Output	REL1
T ON	0.0°C
T- OFF	0.0°C ▼

Up to four time slots can be assigned to each thermostat function. First of all, define the switch-ON times.

Continue to scroll.

1.3.1 Thermost...	
t ON 1	00:00 ▲
t ON 2	00:00
t ON 3	00:00
t ON 4	00:00 ▼

Then, define the switch-OFF times.

Continue via the menu item >Output parameter<.

1.3.1 Thermost...	
t OFF 1	00:00 ▲
t OFF 2	00:00
t OFF 3	00:00
t OFF 4	00:00

Here, the general settings for the assigned outputs are defined.

Continue to scroll.

1.3.7 Output pa...	
Solar pump 1	▶
Thermostat REL1	▶
t-tear-off	10s
n-tear-off	100% ▼

1.3.7 Output pa...	
Thermostat REL1	► ▲
t-tear-off	10s
n-tear-off	100%
Speed delta	10%

Here, the general settings for the assigned outputs are defined.

>t tear-off< and >n tear-off< define how long and at which speed the pumps are to run on starting.

Select an output...

1.3.7 Output pa...	
Algorithm	
	dT
Overtravel time	3s
n-min	50%

...to define the required control algorithm as >dT< or >Fixed T<.

In case of plants with long piping or slow response, overtravel times for the solar circuit, pump and valve can be determined.

Continue to menu item >Tube collector<.

1.3.2 Tube colle...	
Activation <input type="checkbox"/>	
Start	time-dependent
t ON	10min
T ON	20.0°C ▼

To receive correct measured values from the tube collector system, the pump must be switched ON briefly.

By activation of the function, the solar circuit pump can be started time-controlled.

1.3.2 Tube colle...	
t solar 1	20s ▲
n solar 1	100%
t solar 2	0S
n solar 2	30% ▼

The time sequence, the pump ON time and the pump delivery rate as a percentage value can be entered.

1.3.2 Tube colle...	
t solar 2	0S ▲
n solar 2	30%
t start	06:00
t end	20:00

The two time programs are performed one after the other.

Continue via the menu item >Collector cooling<.

Here, collector cooling can be activated: once the collector temperature >T-max col1< is reached, the solar circuit pump operates until the tank limit temperature is reached.

Return to >1.3. Basic functions<.

Continue with >Commissioning<.

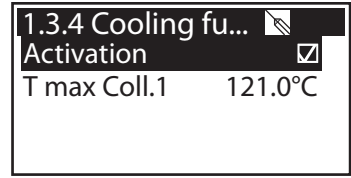

Here, new commissioning can be started - e. g. if a new hydraulic system is to be selected.

=> >Commissioning mode< as of page 21.

Continue with >Delta T control<.



If control algorithms have been defined as >dT< under >1.3.7 Output parameter<, the appropriate outputs can be configured here.

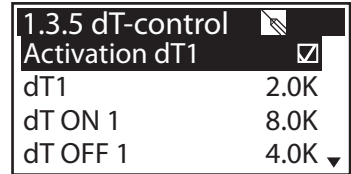

Via >dT ON<, the switch-ON temperature, via >dT OFF<, the switch-OFF temperature and via >dT targ.<, the target differential temperature are set. (Differential temperature between collector and tank, bottom).

Continue with >Fixed T control<.

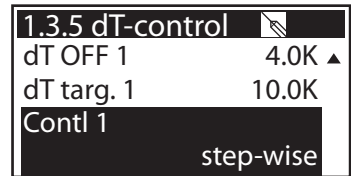

If control algorithms have been defined as >Fixed T< under >1.3.7 Output parameter<, the appropriate outputs can be configured here.

In case of the fixed temperature control, the collector is controlled to the preset temperature via a variable pump delivery rate.

Continue with >Post heating Regu.<.

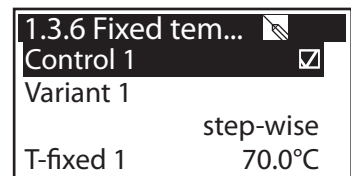



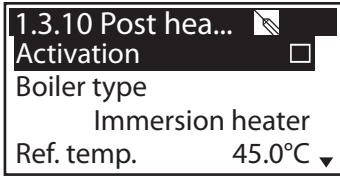

Here, the auxiliary heating can be activated.

The boiler is defined as  
 >Immersion heater< or >Gas/oil<.

If >T-charge< at the upper tank sensor is exceeded by  
 >Hysteresis<, the control activates the auxiliary heating  
 via the boiler until >T-charge< is reached.

Continue with >Protective funct.<.



The following items appear under >1.5. Protective  
 funct.< next to the operation mode menus:

- >Anti-Blocking<
- >Antifreeze protection<
- >Anti-legionellae<

Call up menu item >Anti-Blocking<.



The pumps can be moved daily to prevent them from  
 getting blocked. This function is not activated as long  
 as the pumps are activated in normal operation.

Determine the time of the  
 day and the operating period.

Continue with >Collector defrost.<.

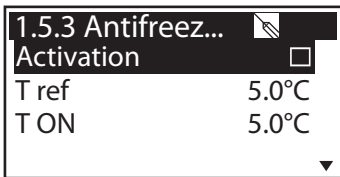

Activation and setting of the anti-freeze  
 protective function for the collector.

Via >T ON<, enter the anti-freeze protection  
 temperature for water-filled plants.

Continue to scroll.

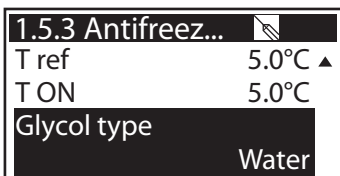

When anti-freeze products are used, the type and the  
 proportion can be entered; the anti-freeze protection  
 temperature is calculated automatically.

Continue with >Anti-legionellae<.

These parameters must be defined by the installer according to the national regulations. Use >Function< to define the period in days (1d - 7d) during which a legionellae disinfection must have occurred at least once.

1.5.4 Anti-legio...	
Repetition	1 day
T legionellae	60.0°C
t-ON	01:00
t-monitor	60min ▼

Use >t-on< to define the time when auxiliary heating may be necessary.

>T-legionellae< defines the disinfection temperature.

>t-monitor< is used to define the minimum disinfection time.

Continue with >Tank cooling<.

1.5.4 Anti-legio...	
T legionellae	60.0°C ▲
t-ON	01:00
t-monitor	60min
Activation	<input type="checkbox"/>

Here, the parameters for tank cooling can be defined.

Use >t-on< and >t-off< to define the time frame in which the tank is to be cooled via the collector. If the >Adjusting balance< is activated, the heat dissipated via the collector is deducted from the energy balance calculation.

Continue with >DiffTemp<.

1.5.5 Cooling fu...	
Activation	<input type="checkbox"/>
t ON	00:00
t OFF	00:07
Adjusting balance	<input type="checkbox"/>

>dT monitoring< is used to define the criteria which lead to fault detection. >dT coll/stor< is used to define a differential temperature between collector and tank, and >t max.coll/tank< for the relevant period of time.

If >dT coll/stor< is exceeded within >t max.coll/tank<, the controller detects a fault.

Continue to scroll.

1.6.2 dT monitor...	
dT coll/stor	30.0K
t max coll/stor	10min
dT rturn/supply	30.0K ▼

The second fault criterion is defined as follows:

>dT return/supply< is used to define a differential temperature between the return and supply flow, >t max return/supply<, the appropriate period of time. If >dT return/supply< is exceeded within >t max return/supply<, the controller detects a fault.

Continue with >Coll. Emerg.OFF<.

1.6.2 dT monitor...	
dT return/supply	30.0K ▲
t max.return/sup.	10min

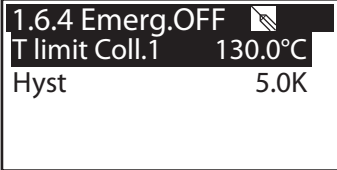

>T limit Coll. 1< is used to switch OFF the appropriate solar circuit pumps to prevent destruction.

Under >Hyst<, the value is entered by which the limit temperature must be undercut to cancel the forced shut-off.

Continue with >Login<.

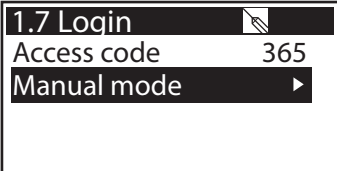

Continue with >Manual mode<.

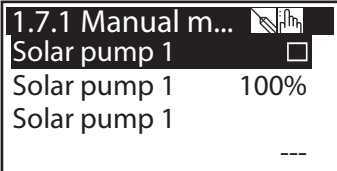

In manual mode, the individual outputs can be activated for testing purposes, e. g. to check that a pump is working properly.

Manual mode can only be exited by pressing ESC.



## Danger!

Mortal danger due to electrocution!  
Before opening the terminal cover,  
disconnect all poles of the power supply reliably!



For disassembly of the differential temperature controller **smart Sol nano**, reverse assembly procedure:

- Disconnect the power supply.
- Open the terminal cover.
- Disconnect all cables.
- Release the wall screw fastening.
- Remove the controller from its mounting location.



## Danger!

Mortal danger due to electrocution!  
When removing the controller, secure all stripped  
cable ends so that they cannot be touched by persons!

Remove cables completely on definite removal.



## Important!

The person who or the institute which is responsible for disposal of the device must not discard the controller with the residual waste, but must ensure correct recycling in accordance with the local provisions!

In case of doubt, ask the local disposal company or the authorized dealer from which you have purchased the device.



The differential temperature controller **smart Sol nano** was developed, manufactured and tested according to stringent quality and safety specifications and corresponds to the state of the art.

The device is subject to the warranty period prescribed by law of 2 years after the date of sale.

The seller shall eliminate all defects in material and workmanship which occur on the product during the warranty period and which impair the product's functionality.

Natural wear and tear does not constitute a defect.

Warranty and liability does not include all damage which is due to one or several of the following reasons:

- Non-compliance with these Assembly and Operating Instructions.
- Inappropriate transport.
- Faulty assembly, commissioning, maintenance or operation.
- Modifications of the structure or tampering with the software of the device.
- Installation of supplementary components which are not approved by the manufacturer.
- Continued use of the controller despite an obvious defect.
- Use of non-approved spare parts and accessories.
- Applications exceeding the intended scope of utilization.
- Inappropriate utilization of the device / improper handling, e. g. ESD.
- Use of the device outside of the admissible technical boundaries.
- Voltage surges, e. g. due to lightning strokes.
- Force majeure.

Further claims based on this warranty obligation, especially compensation for damage exceeding the asset value of the differential temperature controller, are excluded.

Construction, design and project engineering of heating installations are performed by specialist fitters based on the applicable standards and directives.

The functioning and safety of a plant are the exclusive responsibility of the companies commissioned with planning and execution.

Contents and illustrations of this manual have been elaborated to the best of our knowledge and with utmost diligence - we reserve the right of error and technical modifications.

Liability of the manufacturer for inappropriate, incomplete or incorrect information and all damage resulting therefrom is excluded on principle.

# Error report

Error pattern/error description:

---

---

---

---

---

---

---

Error message:

---

---

Software version:

Service Wizard executed:  No  Yes

Screens: TS1:

TS2:

TS3:

TS4:

Wiring: RO1:  Pump  HE

REL:

Service hours: RO1:

RO2:

Equipment/Accessories/Options:

---

---

---

---

---

---

---

---

---

---

## Important!

For repair or replacement of the controller, make sure that completed copies of the commissioning report and of the error report are included!



Name of operator and place of installation:

---

---

---

---

---

Date of commissioning:

Installed hydraulic system:

Collector surface, in total [m<sup>2</sup>]:

Tank sizes [l]:

Anti-freeze agent Type/concentration:

Particularities:

---

---

---

---

---

---

---

---

---

---

The solar thermal plant with the differential temperature controller **smart Sol nano** has been installed and commissioned in an expert fashion.

The owner / operator of the plant was informed in detail and instructed as regards the design, operation, handling, especially in connection with the differential temperature controller **smart Sol nano**.

Commissioning by the company (name/address/telephone number):

---

---

---

---

---

Name of employee:

---

# EC Declaration of conformity

The manufacturer

**emz-Hanauer GmbH & Co.KGaA**  
**Siemensstraße 1**  
**D - 92507 Nabburg**

declares in its sole responsibility that the following product:

Differential temperature controller **smart Sol nano**

to which this Declaration refers, complies with the following directives and standards:

Directive 2006/95/EC of the European Parliament and the Council dated 12 December 2006 on the harmonization of the laws of the Member States relating to electrical equipment designed for use within certain voltage limits.

Directive 2004/108/EC of the European Parliament and the Council dated 15 December 2004 on harmonization of the laws of the Member States relating to electro-magnetic compatibility and abolition of the Directive 89/336/EEC.

Directive 2001/95/EC of the European Parliament and of the Council dated 3 December 2001 regarding general product safety.

Technical regulations, Low-Voltage Directive:

IEC 60730-1:1999 (3<sup>rd</sup> Edition) + A1:2003 + A2:2007

EN 60730-1:2000/AC:2007

Technical regulations, EMC Directive:

EN 60730-1:2000 + A1:2004 + A12:2003 + A13:2004 + A14:2005 (EMC part)

EN 55022:1998 + Corr. 1999 (Class B)

EN 61000-3-2:2006 + A1:2009 + A2:2009

EN 61000-3-3:2008

D - 92507 Nabburg, 27.08.2012,

Signed

**Thomas Hanauer**  
Managing Director

**i.V. Josef Irlbacher**  
Electronic Development Team Manager



<b>A</b> ctive system	12	<b>I</b> ntended Use	8
Anti-blocking	41	<b>L</b> egend to symbols	17
Anti-legionellae	42	Login	28/35/43
Antifreeze	41	<b>M</b> alfunction	30 ff.
Auxiliary heating	16/27/41	Manual mode	43
<b>B</b> oiler control functions	16	<b>O</b> peration of the controller	11
Break-out segments	15	Output parameter	38
<b>C</b> able cross sections	8	<b>P</b> rofessional mode	35 ff.
Cable diameter	15	Protective functions	28/41
Cleaning	6	PWM control signal	22
Collector cooling	40	<b>R</b> otary encoder	10
Commissioning mode	21	<b>S</b> ensor line	6
Connection	15	Service wizard	31 ff.
Contrast	26	Scope of Supplies	8
<b>D</b> ate/Time	21/26	Software version	29
Description	6	Strain relief device	10/15
Disposal	44	<b>T</b> ank cooling	28/42
<b>E</b> mergency OFF	43	Temperature sensor	6
Error list	26/28	Tube collector	27/39
Evaluation	24 ff./36	<b>W</b> all-mounting	14
<b>G</b> uided diagnostic process	30 ff.		
<b>H</b> ydraulic systems	18 ff.		

emz-Hanauer GmbH & Co.KGaA  
Siemensstraße 1  
D - 92507 Nabburg  
Germany

Telephone + 49 - (0) 94 33 - 89 8 - 0  
Telefax + 49 - (0) 94 33 - 89 8 - 188  
info@emz-hanauer.com

[www.emz-hanauer.com](http://www.emz-hanauer.com)

