

smart Sol nano ADVANCE

OPERATING INSTRUCTIONS

DIFFERENTIAL TEMPERATURE CONTROLLER FOR BASIC
SOLAR THERMAL SYSTEMS FOR HEATING DRINKING
WATER AND SUPPORTING HEATING SYSTEMS



These Assembly and Operating Instructions are an integral part of the product.

- > Read Assembly and Operating Instructions carefully before using the product.
- > Keep them in a safe place during the product's service life.

Translation from the German original edition ©emz 2016 - Subject to modifications.

The contents and representations of these Assembly and Operating Instructions are the intellectual property of emz-Hanauer GmbH & Co.KGaA.

Non-authorized disclosure, reproduction, divulgation or editing of this documentation, as well as exploitation, utilization or publication, are prohibited.

The rights to the word and design marks >emz - smart solutions< and >smart Sol nano< are the exclusive property of emz-Hanauer GmbH & Co.KGaA.

The rights to any cited brands, names or logos are the property of their appropriate developers / of the licensees in question.

Table of contents	Page
Symbols used	4
Important fundamental information	5
Description	6
Dimensions	7
Technical Data	8
Designation of the components	10
Operation of the controller	11
Display	12
Opening the terminal cover	13
Wall-mounting	14
Connection to power supply	15
Hydraulic systems	17
Commissioning mode	21
Automatic mode	24
Operation mode	25
Malfunction	30
Replacement of fuse	34
Professional mode	35
Disassembly/Disposal	44
Warranty and liability	45
Error report	46
Commissioning report	47
EC Declaration of conformity	48
Index	49
Appendix – List of messages	50

When handling the differential temperature controller **smart Sol nano** and the entire plant, please make sure that the following safety provisions in the Assembly and Operating Instructions are complied with!



Danger!

Immediate danger for assets, life and limb!



Important!

Important information compliance with which is essential!



Note!

Useful information regarding handling of the device and the plant!



These instructions describe installation, commissioning, operation, repair and disassembly of the differential temperature controller **smart Sol nano** for solar thermal plants.

For operation of the entire plant, the technical documentation of all the components used such as solar collectors, boiler, tank, pumps, mixers and valves etc. must be complied with.



Danger!

Assembly, connection, commissioning, repair and disassembly of the controller may only be performed by a qualified specialist!



The controller is handled by the operator of the entire solar thermal plant, i. e. as a rule by technical non-experts.



Danger!

The controller by no means replaces the safety components required under plant engineering aspects!



Make sure not to use the controller until you have thoroughly read and understood these Assembly and Operating Instructions and the safety provisions. Comply with all safety provisions and involve a specialist in case of doubt.



Important!

The fitter installing the controller must inform the plant operator about operation, functioning and the method of action of the **smart Sol nano**!



Keep these Assembly and Operating Instructions and all reference documents so that they are available if required.

When relocating or when selling the device, hand the documents over to your successor.



Danger!

The device in operation may only be made accessible to adults disposing of appropriate knowledge and experience!



The differential temperature controller **smart Sol nano** is an independent electronic controller for surface-mounting which is used for the control of solar thermal plants.

The controller is equipped with a robust three-part plastic housing which can only be opened by means of tools (screw driver PH2).

Operation is effected by means of only two control elements; indications appear against a backlit colour display.

Before connection of the electrical system, the controller must be mounted firmly to a perpendicular, robust surface (wall).

For its own supply and the supply of the outputs, the controller must be connected to an electrical energy supply system in accordance with the technical data.



Note!



The electrical equipment of the device must be installed firmly and connected to the power supply via a disconnecter ensuring complete isolation from the power supply according to the erection regulations!

Assembly, connection, commissioning, repair and disassembly of the controller are only admissible in a specialist workshop.

To ensure correct operation, temperature sensors type Pt 1000 must be used - the sensor design does not affect function.

Each temperature sensor has two connectors which are equivalent, i. e. interchangeable. Thus, polarity reversal is not an issue.

The sensor lines can be extended up to a length of 100 m, to this effect, a cable cross section of $2 \times 1.5 \text{ mm}^2$ is recommended.



Important!



Make sure that only a dry or slightly moistened cloth is used for cleaning and servicing of the housing, the control elements and the display.

The surfaces must never get into contact with cleaning products or solvents - mat, brittle or slightly dissolved plastic parts must be replaced immediately!

A device with damaged housing must not be operated!

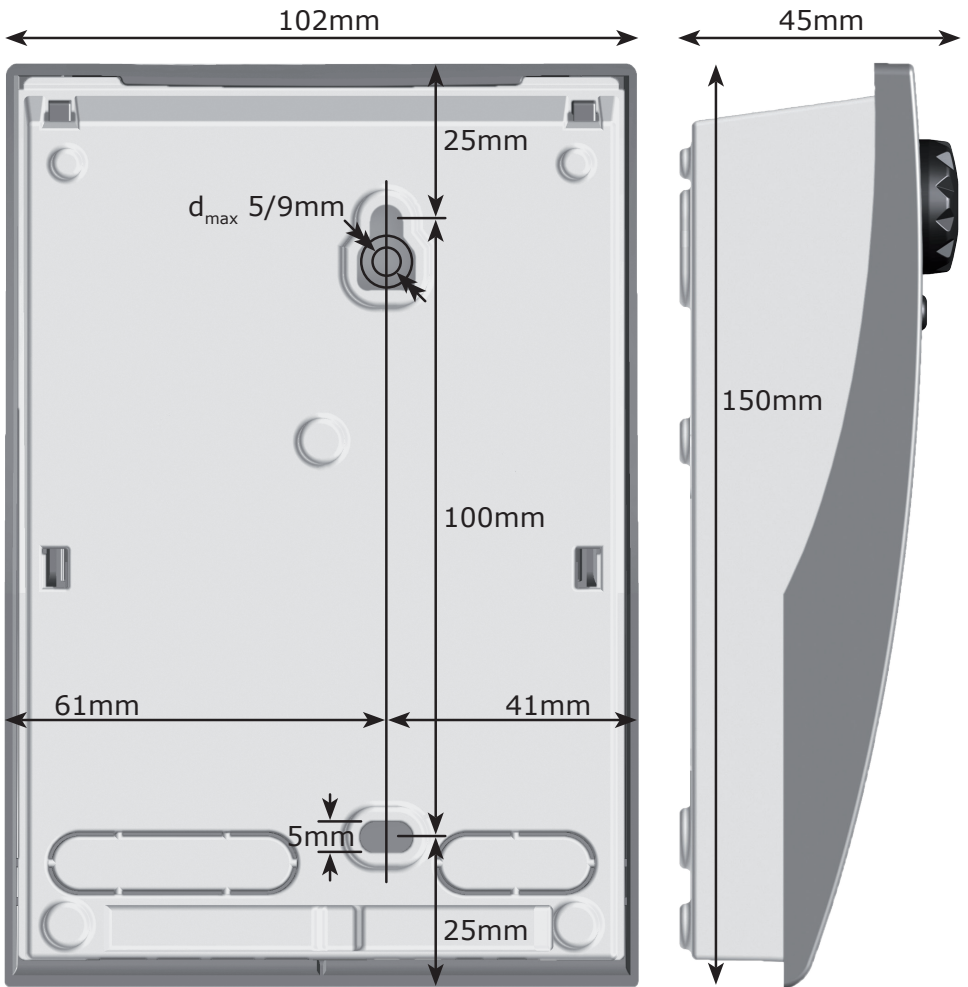

Intended Use

The differential temperature controller may be used exclusively as controller for the control of solar thermal plants. It must be operated within the scope of all the specifications described. Installation and set-up of the controller may only be performed by specialists. The fitter must have read and understood the operating manual. The fitter explains all the relevant functions to the operator. For operation, it is essential that the housing is closed and free of damage.

Scope of supplies

1 Differential temperature controller **smart Sol nano**

1 Instruction manual

Differential temperature controller smart Sol nano

Type of mounting	Wall-mounting
Housing	Plastics, in several parts
Type of protection	IP 20
Dimensions Width x Height x Depth [mm]	102 x 150 x 45
Weight [g] Basic version	320
Storage/operating temperature [°C]	0-40, non-condensation
Handling	via rotary encoder and pushbuttons
Display	FSTN monochrome display 45 x 23mm, backlit
Power reserve of real time clock, at least [h]	8

Max. cross sections to be connected

Cable end sleeve:	0.25 to 0.75 mm ²
Single-wire	0.50 to 1.50 mm ²
Fine-wired	0.75 to 1.50 mm ²

Connection to power supply

Design	3 spring-type terminals PE, N and L
Service voltage [VAC]	230 ±10%
Line frequency [Hz]	50/60 ±1%
Auxiliary consumption typ. [W]	0,93
Power consumption max. [W]	2.7
Fuse	Micro fuse, type 5 x 20 mm, T2A/250 V
Rated pulse voltage [V]	2500

Interfaces TS1 / TS2 / TS3 / TS4

Design	2 spring-type terminals each
Inputs TS1 / TS2 / TS3	
Admissible temperature sensor	Pt 1000
Output TS4	PWM output

Note!

Description of the assignment/configuration at TS4 on page 23.

Triac output RO1

Design	3 spring-type terminals each, PE, N and L
Output voltage [VAC]	230 ±10%
Output power max. per output [VA]	200
Output current max. per output [A]	1

Additional switching output REL: 230V - make contact

Design	3 spring-type terminals
Switching voltage max. [V]	253
Switching capacity max. [VA]	230
Switching current max. [A]	1

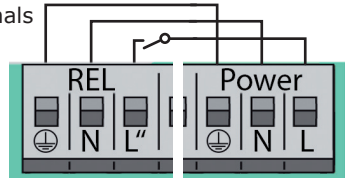

Important!

For system 2, connection of a relay with potential-free contacts between controller and boiler may be necessary depending on the interface.

For system 3, connection of power relay between controller and electric heating is required.

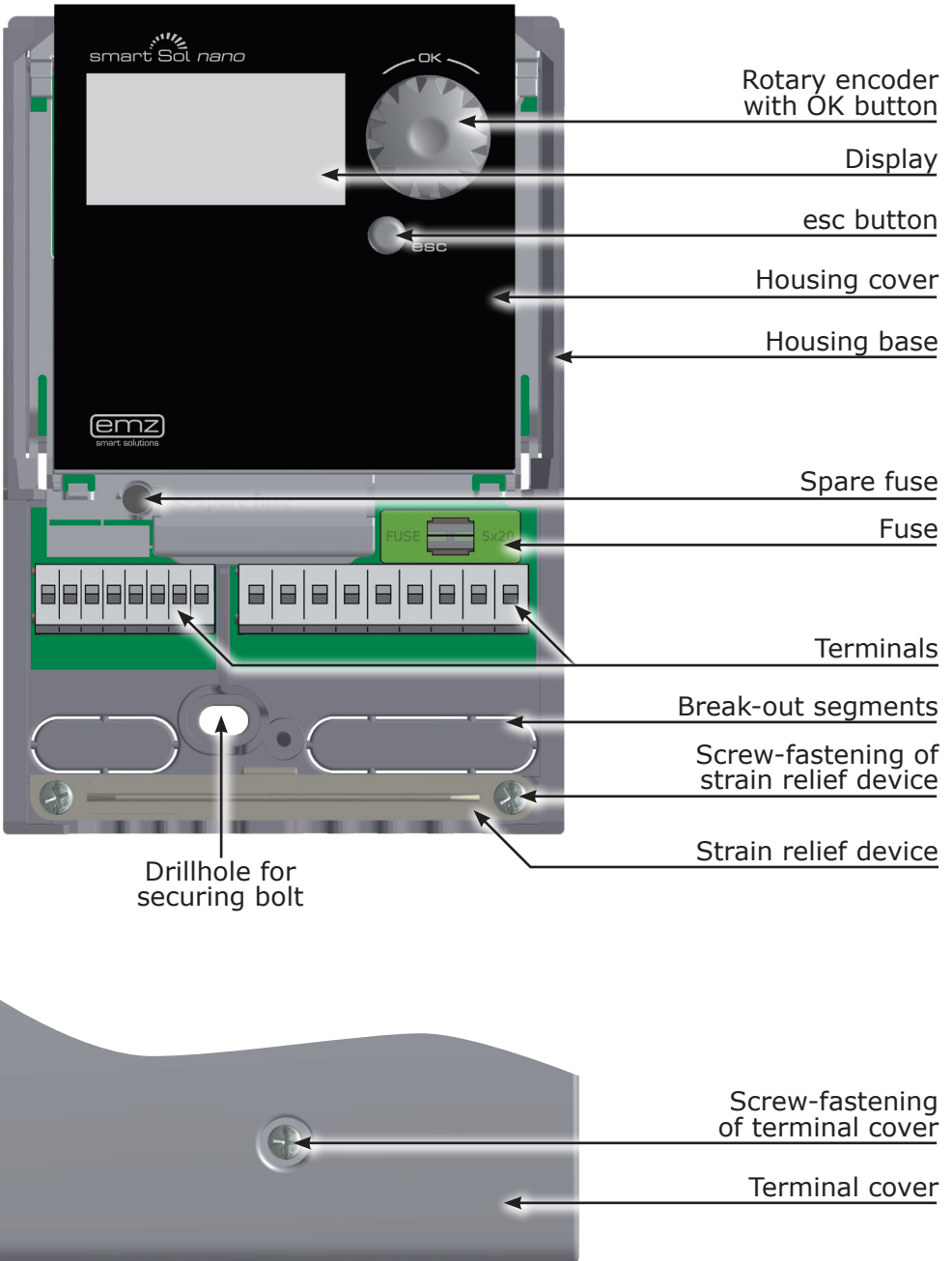

The entire set-up and operation of the differential temperature controller **smart Sol nano** is effected via only two control elements on the device front.

All settings and interrogations are effected via the rotary encoder.

To find a required menu item, turn the rotary encoder to >scroll< through the menu - the selectable option appears on a coloured background on the display.

To confirm the selected menu item, press the rotary encoder. An appropriate submenu is called up, or selection is activated.

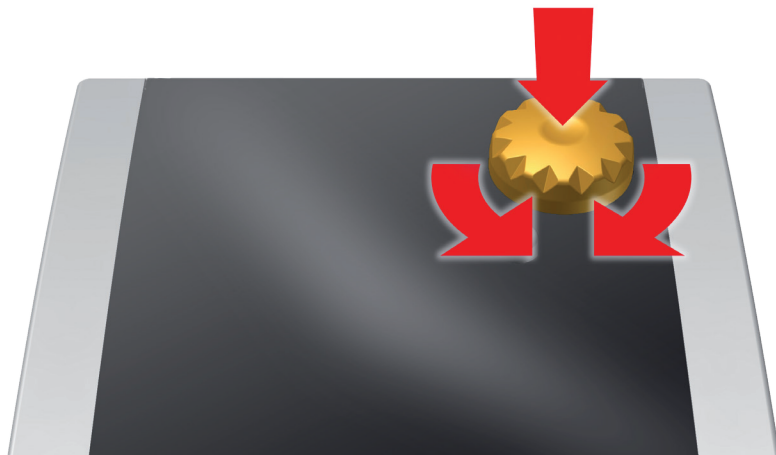

Press the esc button to make the menu return by one level from any subitem.

If no input is made within the preset time (30-255 s), the controller returns automatically to the initial level.

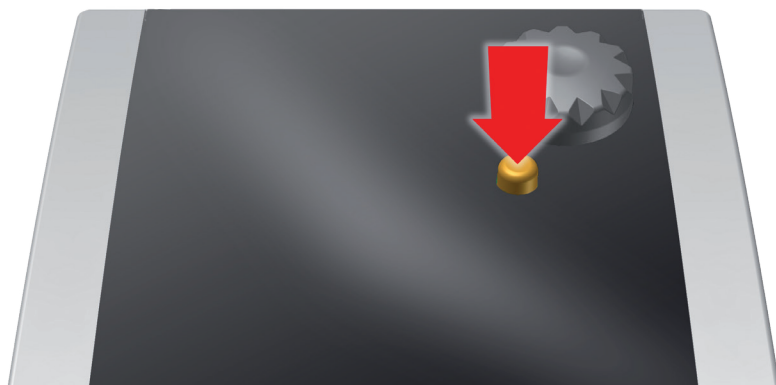

For indication of the operating mode and for communication in case of set-up, malfunction, modification and evaluation, the differential temperature controller **smart Sol nano** is equipped with a full graphics display which is permanently backlit.

The display is active as long as there is supply voltage on the controller.

After a preset time (30 - 255 s), backlighting is dimmed to 10%.

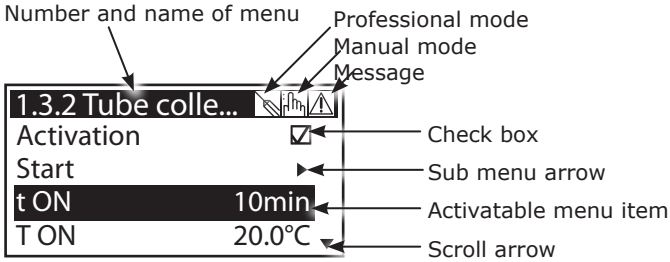

Display elements; example:
communication screen

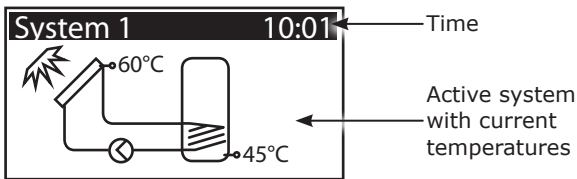

Display elements; example:
information screen



Danger!

Mortal danger due to electrocution! Whenever work is performed on the open terminal cover, all poles of the power supply must be disconnected reliably and protected against being switched on again!

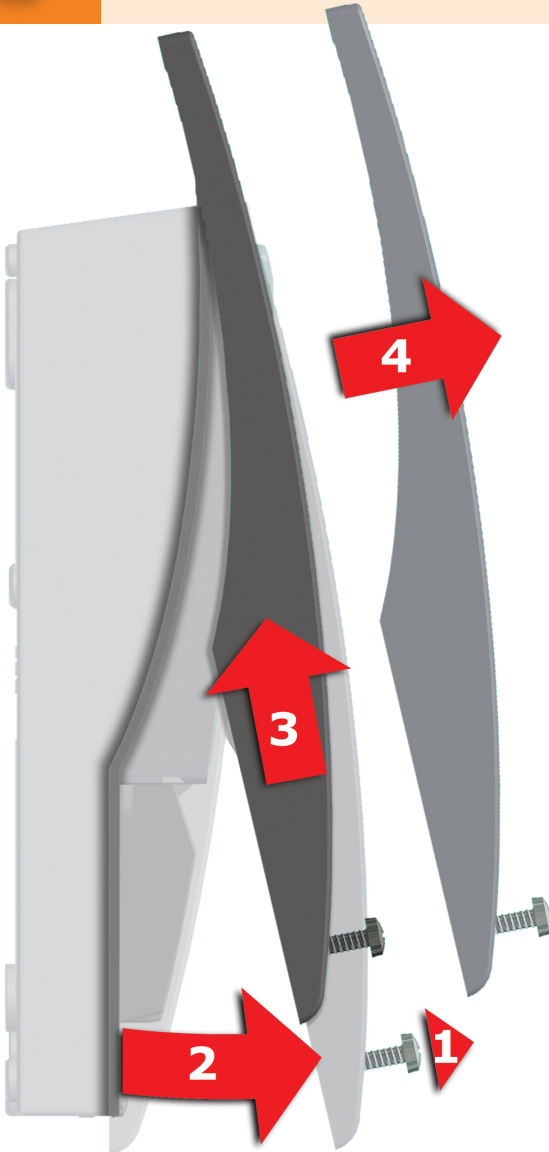

1 Release the lock screw.

2 Swing terminal cover forward ...

3 ... push it upwards ...

4 ... and remove it.

Store the terminal cover carefully and protect it against damage!

To close the terminal cover, reverse the opening procedure.

Important!

The device corresponds to protection type IP 20 - make sure the appropriate prerequisites exist on the envisaged place of installation.

Do not use the housing base as drill template.

A device with damaged housing must not be operated!

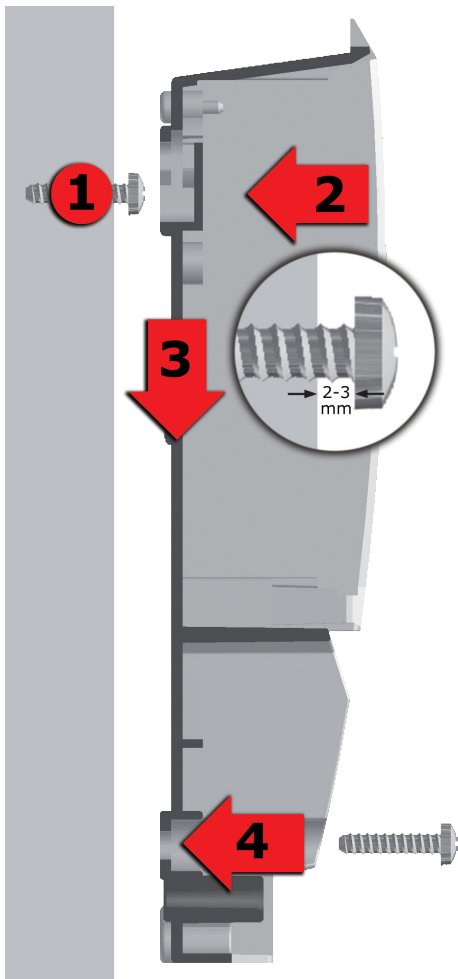

- 1** Fasten the top securing bolt so that a space of 2 to 3 mm is created between the wall and the screw head.
- 2** Move the device so that the upper fastening port is located above the screw head ...
- 3** ... and push it downwards.
- 4** Fasten the lower securing bolt.

If necessary, use dowel pins for wall-mounting!



Danger!

Mortal danger due to electrocution! Whenever work is performed on the open terminal cover, all poles of the power supply must be disconnected reliably and protected against being switched on again!



The differential temperature controller **smart Sol nano** is connected to the power supply via two groups of spring-type terminals which are visible once the terminal cover is opened.

To introduce the cables, release the two screws on the strain relief device; if necessary, remove the strain relief device.

In case of flush mounting of the cables, the break-out segments in the housing base can be removed carefully and the cables routed through these ports.

The spring-type terminals for the power supply, RO1, REL, TS1, TS2, TS3 and TS4 can accommodate solid wires up to a cross section of 1.5 mm².

Appropriate stranded wires must be preassembled with cable end sleeves.

For the strain relief device function, TS1 to TS4 require cable cross sections of at least 5mm, for Power, RO1 and REL at least 7mm.

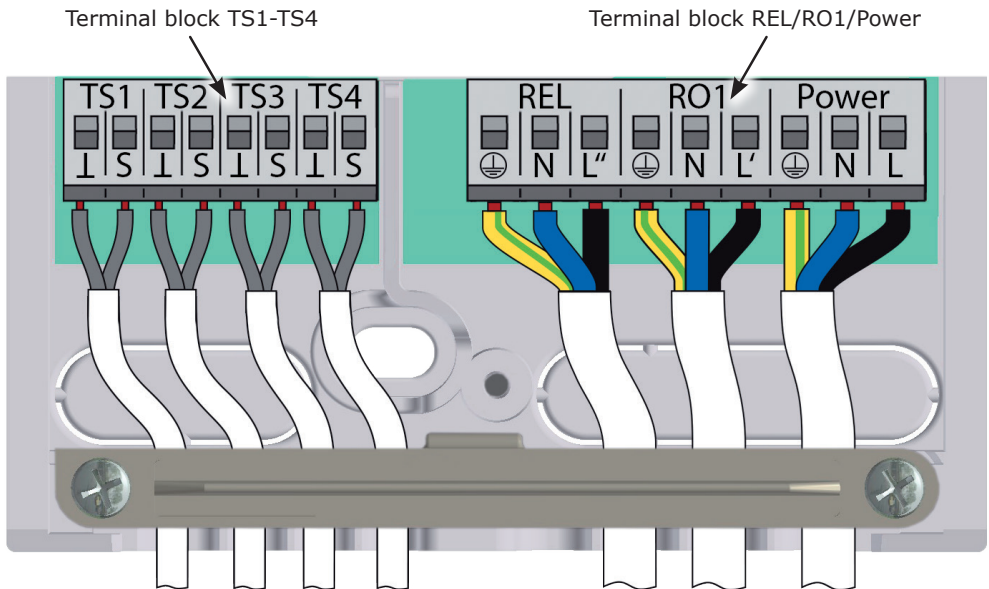

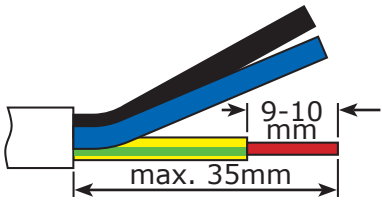

The strain relief device can only ensure solid clamping if the cables are not stripped to a length of over 35 mm.

Insulation of the individual wires must be removed over a length of 9 - 10 mm to ensure safe electric contact in the spring-type terminal.

Stranded wires must be provided with cable end sleeves!

For connection, press the actuation pushbutton of the spring-type terminal using a screwdriver and insert the wire to its stop in the appropriate port.

Release the actuation pushbutton and pull the cable slightly to ensure that it is safely clamped.

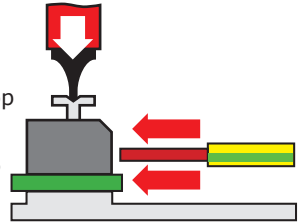

Important!

Before closing the terminal cover, make sure the strain relief device is tightened safely.

Check once more that all cables are in good condition and connected correctly.

Connection of a high-efficiency pump

- Connect the voltage supply of the high-efficiency pump to RO1.
- Connect the signal line of the high-efficiency pump to TS4 so that the signal-routing wire is clamped to the >S< terminal.

Description of the assignment/configuration at TS4 on page 23.

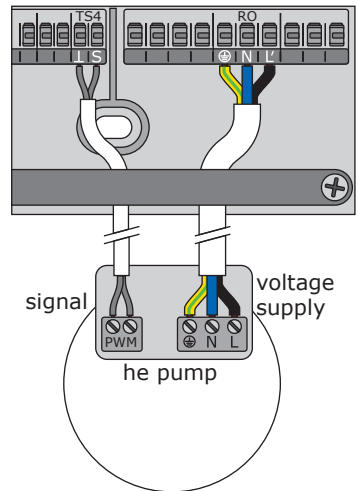

Boiler control functions

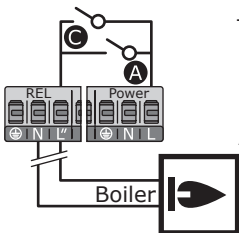

The configuration of the boiler control functions is as shown:

- Anti-legionellae **A** Priority 1
- Auxiliary heating **C** Priority 2

Note!

Define structure and design of the plant already when planning the entire solar thermal system and align the design with the one of the hydraulic systems of the controller!

If you want to complete an existing system or replace the existing controller, please make sure that **smart Sol nano** is compatible with the existing configuration!

The sensors are connected to TS1 to TS3, PWM is connected to TS4, and the devices to be controlled are connected to RO1/REL – The interfaces are assigned to their corresponding functions at commissioning. Description of the assignment/configuration at TS4 on page 23.

 Temperature probes

 Heating pump

 Solar collector panel

 Boiler, e. g. using fossil fuels/ solid fuels/ heat pump etc.



Warm water /
buffer tank with
one heat exchanger



Warm water /
buffer tank with
two heat exchangers



Buffer tank with one
heat exchanger and one
electric heating rod

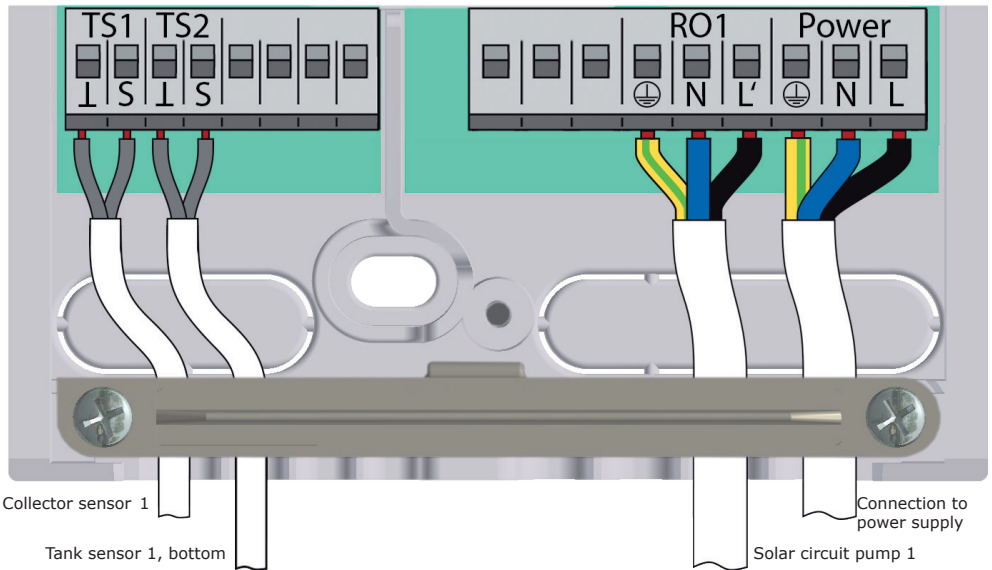
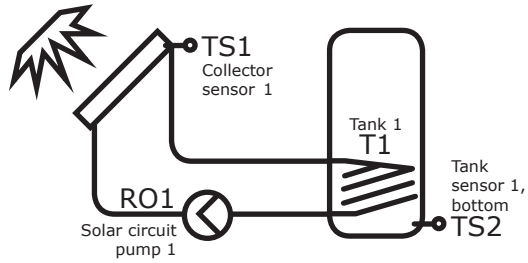

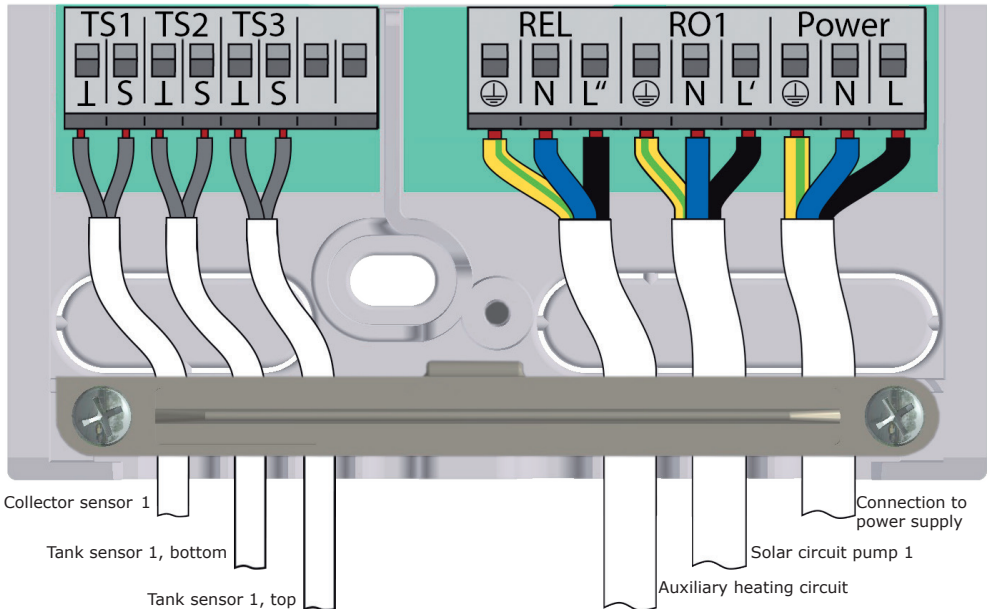
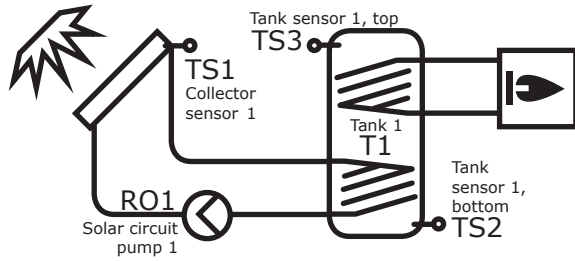

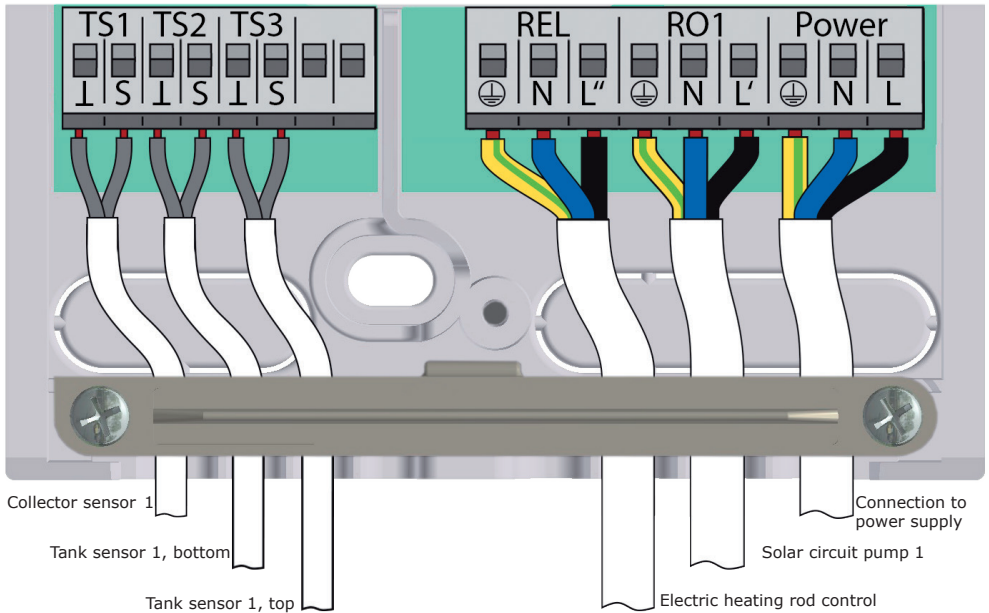
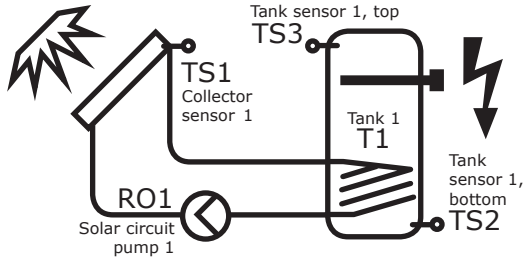

Important!

For commissioning, the controller must be assembled correctly, all inputs and outputs must be connected and ready for operation, the strain relief device must be screw-fastened and the terminal cover closed!

This is an explanation in terms of an example of commissioning of the differential temperature controller **smart Sol nano**; details vary along with the hydraulic configuration and the software version.

Commissioning is communicated in plain text; the user must make a selection, acknowledge and - if applicable - jump to the next menu item.

The differential temperature controller **smart Sol nano** accompanies you during the entire configuration and interrogates everything it must know for optimum operation.

Now, the power supply of the controller must be switched on - the display screen appears.



>0.1 Language< appears after a short booting sequence.

Various languages are available in this version of the **smart Sol nano**.

Activate the required version and acknowledge by pressing >Next<.

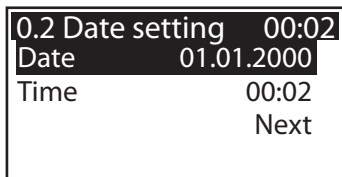

>0.2 Time/date< appears.

Press >OK< - the hour is highlighted.

Turn the rotary encoder until the correct figure appears, and acknowledge via the >OK< button. The controller accepts the value and jumps to the minute setting.

In this way, all values for time and date can be entered, and acknowledged by >Next<.

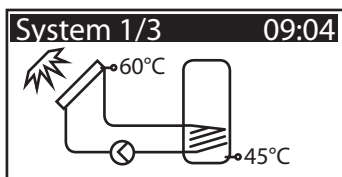

Now, the controller offers the hydraulic systems. By turning the rotary encoder, the required system can be selected (here system 1 of 3 possible ones) and acknowledged via the button >OK<.

>0.7 Checklist< appears.

Here, the submenus >Test outputs< and >HE output< are made available.

Select Test outputs and activate by pressing the >OK< button.

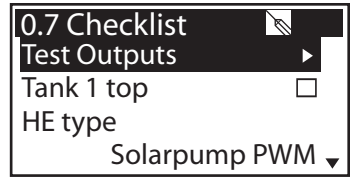

Note!

If the >SP 1 oben< option is selected at the checkbox, an additional temperature sensor can be installed at TS3 in the tank-on-top position.

The temperature value is then displayed during normal operation as information only without any influence on the control.

>0.7.1 Test outputs< appears.

Here, the outputs can be activated manually via the >OK< button to test the function of the activated output or of the connected unit.

If not all pumps and valves are working properly, the plant elements in question and the cabling must be verified and repaired.

Acknowledge by pressing >Next<.

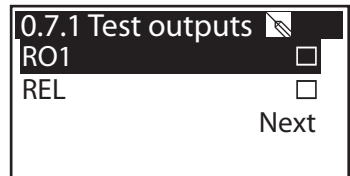

>0.7 Checklist< reappears.

The >HE output< can be defined as >WILO ST25/7 PWM<, >Solar pump analog<, >Solar pump PWM<, >Heater pump analog< or >Heater pump PWM<.

Acknowledge by pressing >Next<.

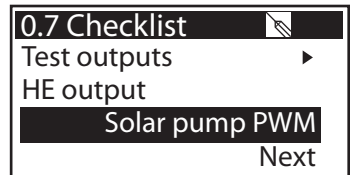

Setting HE output	Control signal for pump speed to TS4	Use for
>WILO ST25/7 PWM<	PWM signal	exclusively for pump type >WILO ST25/7 PWM<
>Solarpump analog<	analog signal 0-10V	high-efficiency pump with analog signal type, >Solar pump<
>Heaterpump analog<	analog signal 0-10V	high-efficiency pump with analog signal type >Heating pump<
>Solarpump PWM<	digital signal PWM	high-efficiency pump with PWM signal characteristic >Solar pump<
>Heaterpump PWM<	digital signal PWM	high-efficiency pump with PWM signal characteristic >Heating pump<
>none<	no control signal	Heating pump without signal input

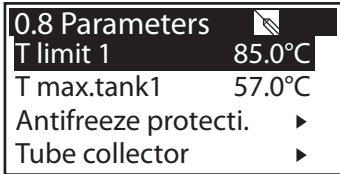

>0.8 Parameters< is displayed.

The most important settings are requested so that adjustments can be made if required. If no adjustments are made, the controller uses the factory settings.

Acknowledge by pressing >Next<.

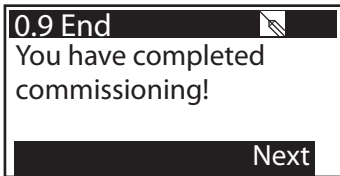

>0.9 End< appears.

By >Next<, the controller changes over to >Automatic mode<.

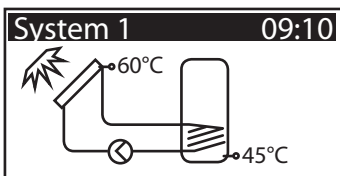

Commissioning is complete.

As of this point, the **smart Sol nano** controls the solar thermal plant automatically.

In automatic mode, the screen displays the date, the time and the active hydraulic system.

The current temperature is displayed for each temperature sensor.

The pump activity is displayed on the display as animation.

There is no need for intervention by the fitter or operator.

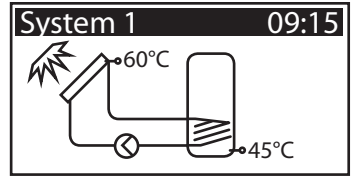

Note!

Check the display screen of the **smart Sol nano** on a regular basis to be able to eliminate any malfunctions promptly!

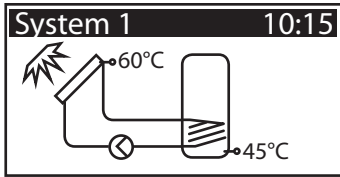

On the controller, the user can make various settings and obtain information about states and processes.
To this effect, press the button >OK< in automatic mode.

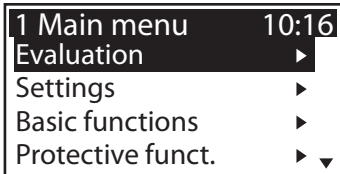

>1 Main menu< appears.
A list of subitems appears
By scrolling ...

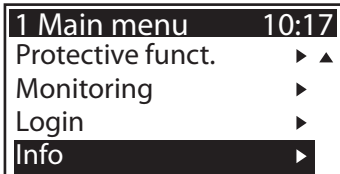

...the lower part of the menu is displayed.
Once the first subitem >Evaluation< is selected, ...

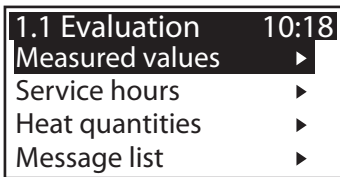

...>1.1 Evaluation< appears.
Another selection level appears.
Once the first subitem >Measured values< is selected, ...

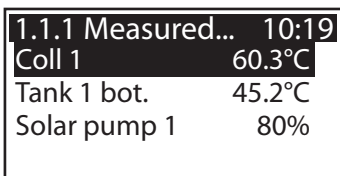

...>1.1.1 Measured val...< appears.
Here, the temperatures and dates concerning the controller are displayed.
If additional tank sensors have been defined on commissioning, these measurands also appear here.
Return to >1.1 Evaluation<.
Once the second subitem >Service hours< is selected, ...

...>1.1.2 Service hours< appears.

The operating time of the activated plant components is displayed in hours. By actuating the menu item >Reset<, all counters are reset to zero.

The values are saved once per day, so that one day max. is „lost“ in case of failure of the power supply.

Return to >1.1 Evaluation<.
Continue with >Heat quantities<.

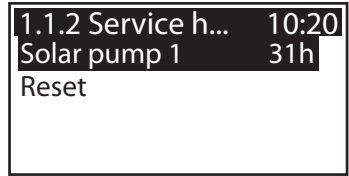

>1.1.4 Heat quantities< appears.

Activation starts a counter which determines the heat yield of the solar plant. Press >Reset< to reset the counter to 0.

Return to >1.1 Evaluation<.
Continue with >Message list<.

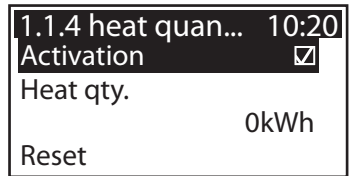

>1.1.5 Message list< appears.

Here, a table of the last errors occurred appears for information.

(A list of messages is attached to these operating instructions)

By selecting a Message ...

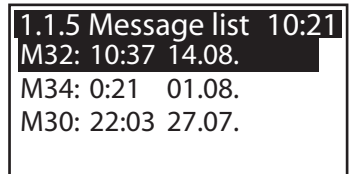

... the message appears in plain text.

If necessary, take the appropriate measures.

Return to >1 Main menu<. Continue with >Settings<.

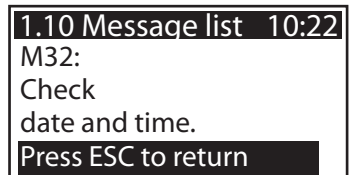

>1.2 Settings< appears.

Another selection level appears.

Once the first subitem >Date/Time< is selected, ...

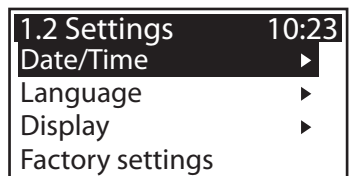

1.2.1 Date setting 10:24	
Date	17.08.2012
Time	10:24

...>1.2.1 Date settings< appears.

Here, date and time can be set in case of deviation or an extended period of deenergizing.

Select the subitem >Date< or >Time< by pressing >OK<.

1.2.1 Date setting 10:24	
Date	17.08.2012
Time	10:24

One group of figures each is activated and can be varied via the rotary encoder; whenever >OK< is pressed, the activation jumps to the next group.

Return to >1.2 Settings<. Continue with >Language<.

1.2.2 Language 10:25	
Deutsch	<input type="checkbox"/>
English	<input checked="" type="checkbox"/>
Français	<input type="checkbox"/>
Italiano	<input type="checkbox"/>

>1.2.2 Language< appears.

Here, the user can change over to another available language.

Continue with >Display<.

1.2.7 Display 10:27	
Contrast	80%
Blanking time	180s

>1.2.7 Display< appears.

>Contrast< serves to adjust the contrast of the display in steps of 1% from 70% to 100%.

>Blanking time< is used to determine the time after which, in case of inactivity, backlighting is switched off. Adjustable in the range from 30 to 255 seconds.

Return to >1.2 Settings<.

1.2 Settings 10:28	
Activate factory settings?	No
Yes	

The last menu item is >Factory settings<.

By selecting and pressing the button >OK<, followed by >esc<, the preset values are deleted and replaced by the factory settings.

Return to >1 Main menu<.

Continue with >Basic functions<.

>1.3 Basic functions< appears.

Another selection level appears.

Once the first subitem >Tube collector< is selected, ...



... >1.3.2 Tube collectors< appears.

This option is to be activated in case vacuum tube collectors are used.

Return to >1.3 Basic functions<.
Continue with >Delta T control<.

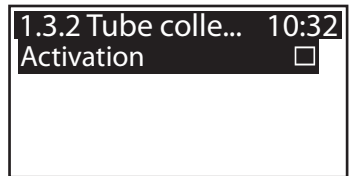

>1.3.5 dT control< appears.

Here, parameters of the controller can be changed.

The factory settings of the **smart Sol nano** can be used for almost all plants.

Ask a fitter before making changes at this point.

Return to >1.3 Basic functions<.
Continue with >Post heating Regu.<.

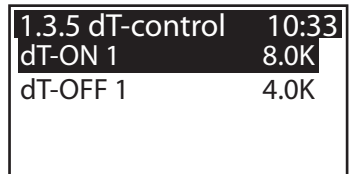

>1.3.10 Post hea...< appears.

The auxiliary heating control reacts to the values of the upper tank sensor. In case of values below >T-charge< minus the hysteresis, the control activates the auxiliary heating via the boiler. Once the set value is reached the auxiliary heating process is terminated. As long as the tank is charged by the solar circuit, the reheating function is deactivated.

Continue with >Protective functions<.

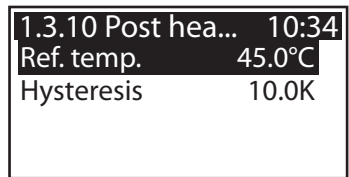

>1.5 Protective funct.< appears.

Another selection level appears.

Continue with >Tank cooling<.

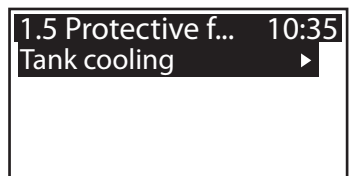



>1.5.5 Cooling funct.< appears.

This option must be activated if, during a heat wave, the heat input exceeds the energy withdrawal.

In this case, the controller cools the tank via the collectors, e. g. at night.

Return to >1 Main menu<. Continue with >Monitoring<.



>1.6 Monitoring< appears.

Here, the message list can be called up. The required information appears on the display.

(A list of messages is attached to these operating instructions)

Return to >1 Main menu<. Continue with >Login<.

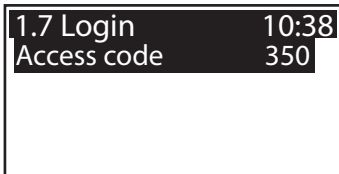

>1.7 Login< appears.

Here, the fitter can enter his/her access code to perform further settings and changes.

Return to >1 Main menu<.

Continue with >Info<.

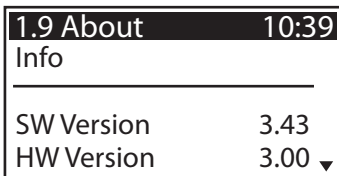

>1.9 About< appears.

Here, the software and hardware version of the controller, the serial number and the date of commissioning appear.

This information is required for repairs and for version management.

With installer access, you can also switch to 60 Hz operation in this case if the controller is operated at 230V/ 60 Hz.

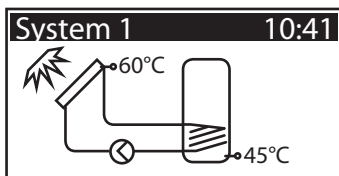

If no entry is made within the preset time (30 - 255 s) on the **smart Sol nano**, the display returns to >System<.

To return there, you can also push the button >esc<.

The screen on top right shows the >Attention< symbol which points out a notification or an operating malfunction.

Select via >OK<.

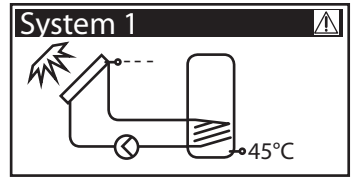

If >Safety function< appears in the display, this is a message, no malfunction.

In this case, there is no deficiency, but limits have been exceeded.

With a flashing warning symbol, the controller indicates that a protective function has been triggered.

Continuously lit symbol means "Error"

The message is only active until normal operation has been restored.

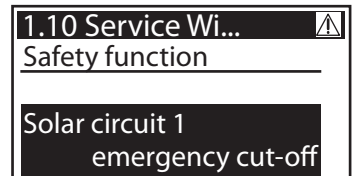

Note!

If a malfunction message appears in the display, the operator can define the possible causes by means of the Service Wizard so that he/she can provide the fitter with precise information.

The differential temperature controller **smart Sol nano** communicates malfunction processes in plain text. The Service Wizard indicates the possible causes of malfunctions on the basis of the detected symptoms and thus supports immediate and comfortable detection of deficiencies. There may be various deficiencies in a solar thermal system, which require a wide variety of approaches. The controller communicates every step to the operator or fitter via the screen, so that there is no need to describe all malfunctions in detail in this operating manual.

Here, a malfunction message with troubleshooting process is presented as an example.

Danger!

Mortal danger due to electrocution!
For troubleshooting on the plant, disconnect all poles of the power supply reliably and protect it them against being switched on again!



>1.10 Service Wizard< appears.

The malfunction appears in plan text - here:

>M02: Breakage of sensor on TS1!<.

If an analysis/repair is not required at present, press >Menu< to return to the main menu.



The Service Wizard helps detect possible causes of malfunctions.

Acknowledge by pressing >Next<.

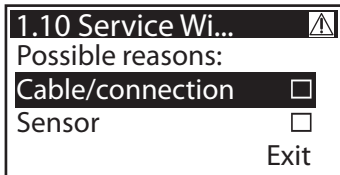

For this malfunction, the following causes are assumed: >Cable/connection< or >Sensor< - select the first menu item and confirm by pressing >OK<.

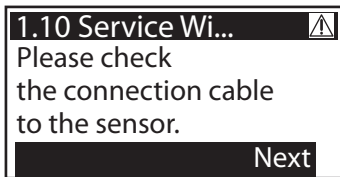

The controller here provides the troubleshooting instruction to check the connection cable.

Perform the measure in accordance with the recommendation.

Acknowledge by pressing >Next<.

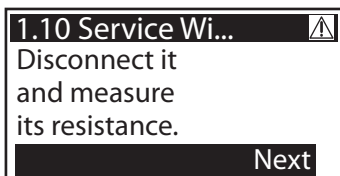

More detailed instructions are available if required.

Acknowledge by pressing >Next<.

The troubleshooting result is interrogated.

Continue via >Yes< for the case that the malfunction has been determined.

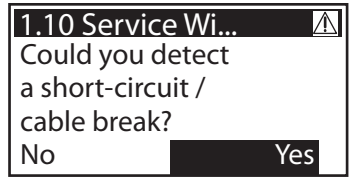

Repair information appears.

Perform the appropriate repair work.

Exit the >Service Wizard< by pressing >Exit<.

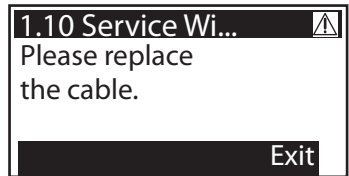

If the cause of the malfunction has not yet been determined, troubleshooting can be continued.

Continue with >No<.

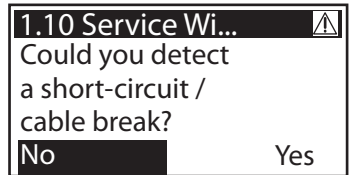

Select all the sources of malfunctions listed, and confirm via >OK<.



Appropriate instructions appear for each source of faults.

Perform the measure in accordance with the recommendation.

Continue with >Explanation<.





A part of the information and instructions may be provided in close detail, so that ...

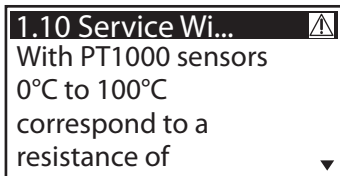

...the texts...

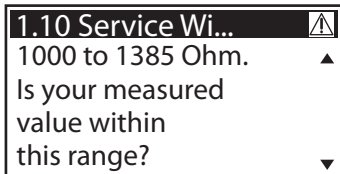

... may well take several screens.



After description of the troubleshooting measure, the result determined by you is interrogated...

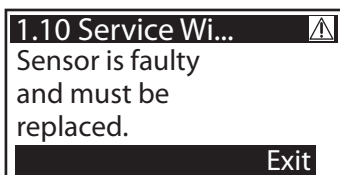

... and the appropriate logical conclusion is made, the repair work displayed.

After elimination of the malfunction, the plant screen without the >Attention< symbol appears again on the display, automatic mode is continued.



Danger!

Mortal danger due to electrocution! Before opening the terminal cover, disconnect the power supply reliably!

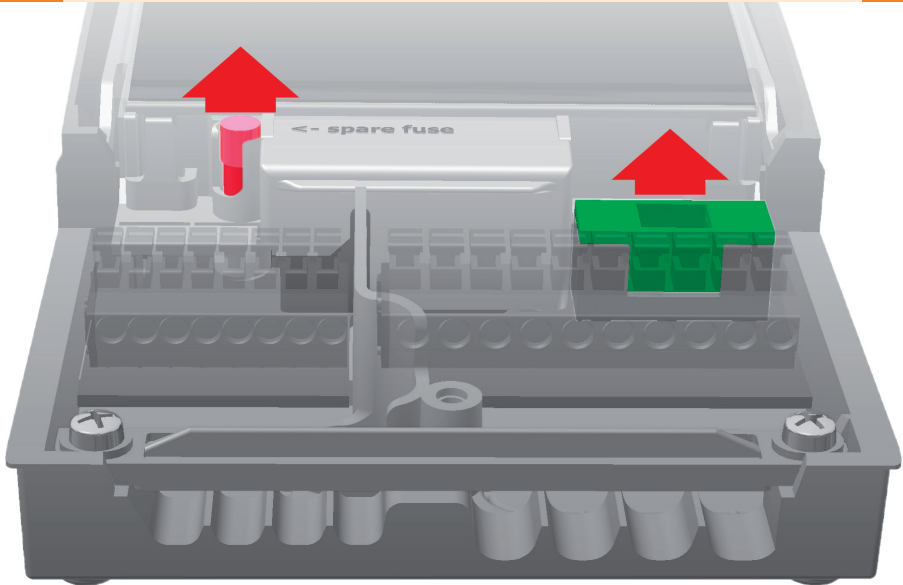

To remove the device fuse, open the terminal cover. Above the right-hand group of terminals, the fuse base and a spare fuse are located. Pull the upper part of the support and the spare part out. The fuse link is clamped in the formed piece and is removed together with the plastic holder.



Now, push the micro-fuse laterally out of its holder. The fuse link is installed by reversing the above order. Make sure to procure yourself immediately a new spare fuse!



Danger!

Risk of fire due to overload or short-circuit!
Only use fuse links type 5 x 20 mm, T2A!



Important!

In professional mode, settings are made which require detailed knowledge of the heating and solar plant. Moreover, solid specialist knowledge regarding control engineering, hydraulics and solar thermal water heating is required!

If a single parameter is changed, this may affect the safety, function and efficiency of the entire plant!

Leave the settings in professional mode to a specialist workshop, the fitter or heating installer!

Modifications by non-experts tend to result in damage to the plant, rather than to an improvement of its efficiency!

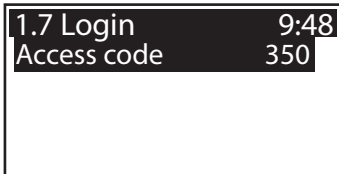

To enter the professional mode, select >1.7 Login< from the main menu, activate and ...

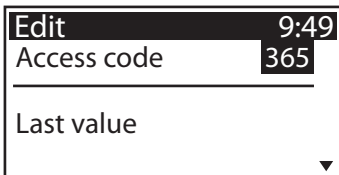

... enter the access code.

The access code to professional mode is >365<.

The fact that the fitter must be available for his/her customers on 365 days per year may serve as a mnemonic trick.

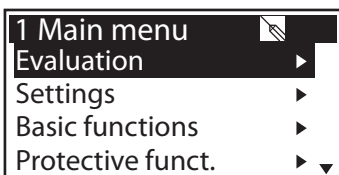

After having returned to >1 Main menu<, the screen shows a list of subitems as in operation mode.

In menu item >1.1 Evaluation<, enhanced setting options for the operation mode are only available in subitem >Heat quantity<.

Continue with >Heat quantities<.

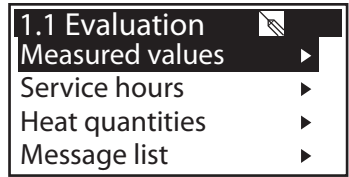

Here, precise settings must be made to enable the controller to set up the heat quantity balance as precisely as possible.

Continue to scroll.

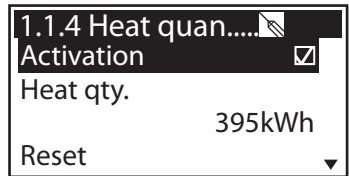

In addition to the operation mode's functions, the sensors in the return and supply lines are assigned.

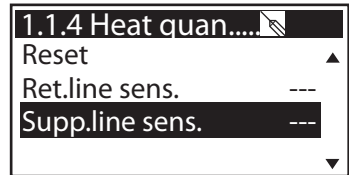

The filling can be defined as water, Tyfocor, propylene glycol or ethylene glycol.

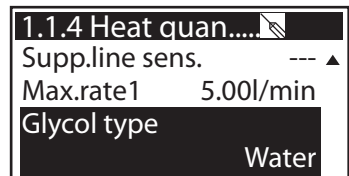

The following items appear under >1.2. Settings< next to the operation mode menus:

- >Temp. limitation<
- >Max.temp.shutoff<
- >Min. temperature<

Call up menu item >Temp. limitation<.

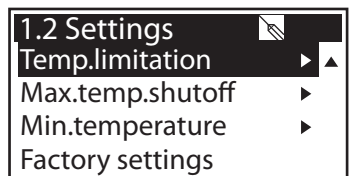

1.2.3 Temp.limit...	
Hyst	5.0K
T limit 1	60.0°C
If T-limit>60°, anti-scalding protection must be instal	

If the temperature in tank 1 exceeds the value >T limit 1< the solar circuit pump is switched off unconditionally. The pump is not switched on again until the actual temperature falls below the value >T limit< by the hysteresis >Hyst<.

Example: T limit =60°C minus Hyst=5K
=> Reclosing temperature 55°C.

Continue via the menu item >Max.temp.shutoff<.

1.2.5 Max.temp...	
T-max tank 1	59.0°C

Maximum temperature of the tank 1, to avoid excessively hot water in the tank; the tank in question is only charged to its >T max<.

In case of collector overheating, the tank can be charged up to >T-limit<.

Continue via the menu item >Min. temperature<.

1.2.6 Min.tempe...	
Activation	<input type="checkbox"/>
T min Coll.1	20.0°C
Hyst. Coll.1	2.0K

To increase efficiency on charging the tanks, the minimum temperature to be present at the collector in question is entered via >T min. Coll<.

The relevant hysteresis value represents the difference between the switch-ON and switch-OFF temperature.

Return to >Main menu<. Continue with >Basic functions<.

1.3 Basic functi...	
Output parameter	▶
Tube collector	▶
Collector cooling	▶
Commissioning	▶

The following items appear under >1.3. Basic functions< next to the operation mode menus:

- >Output parameter<
- >Collector cooling< ...

1.3 Basic functi...	
Collector cooling	▶ ▲
Commissioning	▶
Delta T control	▶
Post heating Regu.	▶

... and enhanced menus regarding the



- >Delta T control<
- >Post heating Regu.<

Call up the menu item >Output parameter<.

Here, the general settings for the assigned outputs are defined.

>t tear-off< and >n tear-off< define how long and at which speed the pumps are to run on starting.



Select an output...

1.3.7 Output pa... 	
Solar pump 1 	
t-tear-off	10s
n-tear-off	100%
Speed delta	10%

...to define the required control algorithm as >dT< or >Fixed T<.



In case of plants with long piping or slow response, overtravel times for the solar circuit, pump and valve can be determined.

Continue to menu item >Tube collector<.



1.3.7 Output pa... 	
Algorithm	
	dT
Overtravel time	3s
n-min	50% 

To receive correct measured values from the tube collector system, the pump must be switched ON briefly.

By activation of the function, the solar circuit pump can be started time-controlled.



1.3.2 Tube colle... 	
Activation <input type="checkbox"/>	
Start	time-dependent
t ON	10min
T ON	20.0°C 

The time sequence, the pump ON time and the pump delivery rate as a percentage value can be entered.

1.3.2 Tube colle... 	
t solar 1	20s 
n solar 1	100%
t solar 2	0S
n solar 2	30% 

The two time programs are performed one after the other.

Continue via the menu item >Collector cooling<.

1.3.2 Tube colle... 	
t solar 2	0S 
n solar 2	30%
t start	06:00
t end	20:00

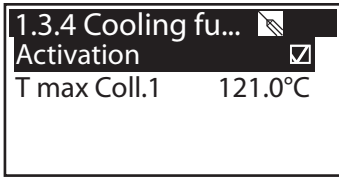

Here, collector cooling can be activated: once the collector temperature >T-max col1< is reached, the solar circuit pump operates until the tank limit temperature is reached.

Return to >1.3. Basic functions<. Continue with >Commissioning<.

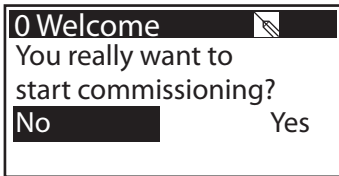

Here, new commissioning can be started - e. g. if a new hydraulic system is to be selected. => >Commissioning mode< as of page 21.

Continue with >Delta T control<.

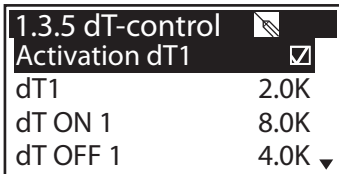

If control algorithms have been defined as >dT< under >1.3.7 Output parameter<, the appropriate outputs can be configured here.

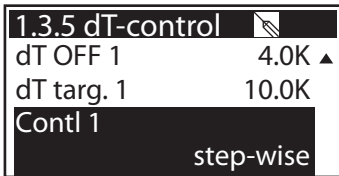

Via >dT ON<, the switch-ON temperature, via >dT OFF<, the switch-OFF temperature and via >dT targ.<, the target differential temperature are set. (Differential temperature between collector and tank, bottom).

Continue with >Fixed T control<.

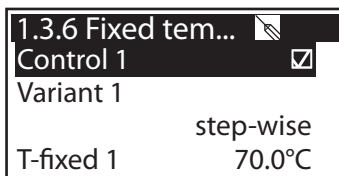

If control algorithms have been defined as >Fixed T< under >1.3.7 Output parameter<, the appropriate outputs can be configured here.

In case of the fixed temperature control, the collector is controlled to the preset temperature via a variable pump delivery rate.

Continue with >Post heating Regu.<.

Here, the auxiliary heating can be activated.

The boiler is defined as
>Immersion heater< or >Gas/oil<.

If >T-charge< at the upper tank sensor is exceeded by
>Hysteresis<, the control activates the auxiliary heating
via the boiler until >T-charge< is reached.

Continue with >Protective funct.<.

The following items appear under >1.5. Protective
funct.< next to the operation mode menus:

- >Anti-Blocking<
- >Antifreeze protection<
- >Anti-legionellae<

Call up menu item >Anti-Blocking<.

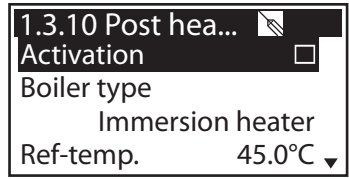

The pumps can be moved daily to prevent them from
getting blocked. This function is not activated as long
as the pumps are activated in normal operation.

Determine the time of the
day and the operating period.

Continue with >Collector defrost.<.

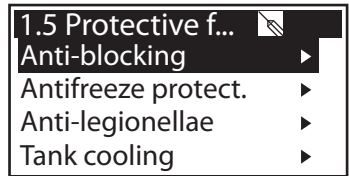

Activation and setting of the anti-freeze
protective function for the collector.

Via >T ON<, enter the anti-freeze protection
temperature for water-filled plants.

Continue to scroll.

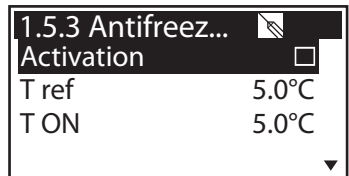

When anti-freeze products are used, the type and the
proportion can be entered; the anti-freeze protection
temperature is calculated automatically.

Continue with >Anti-legionellae<.

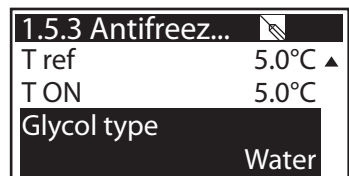

1.5.4 Anti-legio...	
Repetition	1 day
T legionellae	60.0°C
t-ON	01:00
t-monitor	60min ▼

These parameters must be defined by the installer according to the national regulations. Use >Function< to define the period in days (1d - 7d) during which a legionellae disinfection must have occurred at least once.

1.5.4 Anti-legio...	
T legionellae	60.0°C ▲
t-ON	01:00
t-monitor	60min
Activation	<input type="checkbox"/>

Use >t-on< to define the time when auxiliary heating may be necessary.

>T-legionellae< defines the disinfection temperature.

>t-monitor< is used to define the minimum disinfection time.

Continue with >Tank cooling<.

1.5.5 Cooling fu...	
Activation	<input type="checkbox"/>
t ON	00:00
t OFF	00:07
Adjusting balance	<input type="checkbox"/>

Here, the parameters for tank cooling can be defined.

Use >t-on< and >t-off< to define the time frame in which the tank is to be cooled via the collector.

If the >Adjusting balance< is activated, the heat dissipated via the collector is deducted from the energy balance calculation.

Continue with >DiffTemp<.

1.6.2 dT monitor...	
dT coll/stor	30.0K
t max coll/stor	10min
dT rturn/supply	30.0K ▼

>dT monitoring< is used to define the criteria which lead to fault detection. >dT coll/stor< is used to define a differential temperature between collector and tank, and >t max.coll/tank< for the relevant period of time.

If >dT coll/stor< is exceeded within >t max.coll/tank<, the controller detects a fault.

Continue to scroll.

1.6.2 dT monitor...	
dT return/supply	30.0K ▲
t max.return/sup.	10min

The second fault criterion is defined as follows:

>dT return/supply< is used to define a differential temperature between the return and supply flow, >t max return/supply<, the appropriate period of time.

If >dT return/supply< is exceeded within >t max return/supply<, the controller detects a fault.

Continue with >Coll. Emerg.OFF<.

>T limit Coll. 1< is used to switch OFF the appropriate solar circuit pumps to prevent destruction.

Under >Hyst<, the value is entered by which the limit temperature must be undercut to cancel the forced shut-off.

Using the parameters >max. T-limit< or >max. T-limit HE<, the maximum possible value of >T limit Coll.1< can be pre-set by the installer (the applicable value is displayed only).

Continue with >Login<.



Continue with >Manual mode<.

In manual mode, the individual outputs can be activated for testing purposes, e. g. to check that a pump is working properly.

>AUTO< corresponds to normal operation - for manual mode >ON< or >OFF< can be selected.

Manual mode can only be exited by pressing ESC.

1.6.4 Emerg.OFF 	
T limit Coll.1	130.0°C
Hyst	5.0K
max. T-limit	130.0°C
max. T-limit HE	120.0°C

1.7 Login 	
Access code	365
Manual mode	

1.7.1 Manual m... 	
Solarpump 1	AUTO
Solarpump 1	100%
Solarpump 1	---



Danger!

Mortal danger due to electrocution!
Before opening the terminal cover,
disconnect all poles of the power supply reliably!



For disassembly of the differential temperature controller **smart Sol nano**, reverse assembly procedure:

- Disconnect the power supply.
- Open the terminal cover.
- Disconnect all cables.
- Release the wall screw fastening.
- Remove the controller from its mounting location.



Danger!

Mortal danger due to electrocution!
When removing the controller, secure all stripped
cable ends so that they cannot be touched by persons!

Remove cables completely on definite removal.



Important!

The person who or the institute which is responsible for disposal of the device must not discard the controller with the residual waste, but must ensure correct recycling in accordance with the local provisions!

In case of doubt, ask the local disposal company or the authorized dealer from which you have purchased the device.



The differential temperature controller **smart Sol nano** was developed, manufactured and tested according to stringent quality and safety specifications and corresponds to the state of the art.

The device is subject to the warranty period prescribed by law of 2 years after the date of sale.

The seller shall eliminate all defects in material and workmanship which occur on the product during the warranty period and which impair the product's functionality.

Natural wear and tear does not constitute a defect.

Warranty and liability does not include all damage which is due to one or several of the following reasons:

- Non-compliance with these Assembly and Operating Instructions.
- Inappropriate transport.
- Faulty assembly, commissioning, maintenance or operation.
- Modifications of the structure or tampering with the software of the device.
- Installation of supplementary components which are not approved by the manufacturer.
- Continued use of the controller despite an obvious defect.
- Use of non-approved spare parts and accessories.
- Applications exceeding the intended scope of utilization.
- Inappropriate utilization of the device / improper handling, e. g. ESD.
- Use of the device outside of the admissible technical boundaries.
- Voltage surges, e. g. due to lightning strokes.
- Force majeure.

Further claims based on this warranty obligation, especially compensation for damage exceeding the asset value of the differential temperature controller, are excluded.

Construction, design and project engineering of heating installations are performed by specialist fitters based on the applicable standards and directives.

The functioning and safety of a plant are the exclusive responsibility of the companies commissioned with planning and execution.

Contents and illustrations of this manual have been elaborated to the best of our knowledge and with utmost diligence - we reserve the right of error and technical modifications.

Liability of the manufacturer for inappropriate, incomplete or incorrect information and all damage resulting therefrom is excluded on principle.

Error pattern/error description:

Error message:

Software version:

Service Wizard executed: No Yes

Screens: TS1:

TS2:

TS3:

TS4:

Wiring: RO1: Pump HE

REL:

Service hours: RO1:

REL:

Equipment/Accessories/Options:

Important!

For repair or replacement of the controller, make sure that completed copies of the commissioning report and of the error report are included!



The manufacturer

emz-Hanauer GmbH & Co.KGaA
Siemensstraße 1
D - 92507 Nabburg

declares in its sole responsibility that the following product:

Differential temperature controller **smart Sol nano**

to which this Declaration refers, complies with the following directives and standards:

Directive 2006/95/EC of the European Parliament and the Council dated 12 December 2006 on the harmonization of the laws of the Member States relating to electrical equipment designed for use within certain voltage limits.

Directive 2004/108/EC of the European Parliament and the Council dated 15 December 2004 on harmonization of the laws of the Member States relating to electro-magnetic compatibility and abolition of the Directive 89/336/EEC.

Directive 2001/95/EC of the European Parliament and of the Council dated 3 December 2001 regarding general product safety.

Technical regulations, Low-Voltage Directive:

EN 60730-1:2000

Technical Report no. S34163-00-00TJ, S34163-00-01TJ*

Test institute/Laboratory: mikes-testingpartner GmbH, Strasskirchen

Technical regulations, EMC Directive:

EN 60730-1:2000 + A1:2004 + A12:2003 + A13:2004 + A14:2005 (EMC part)

EN 55022:1998 + Corr. 1999 (Class B)

EN 61000-3-2:1995 + corr. July 1997 + A1: 1998 + A2:1998 + A14:2000

EN 61000-3-3:1995 + A1:2001 + A2:2005

Test Report no. E34488-00-00HP*

Test institute/Laboratory: mikes-testingpartner GmbH, Strasskirchen

*The original test reports are available at manufacturer.

D - 92507 Nabburg, 20.07.2012,

Signed

Thomas Hanauer
Managing Director

i.V. Josef Irlbacher
Electronic Development Team Manager

60Hz operation	29	I ntended Use	8
A ctive system	12	L egend to symbols	17
Anti-blocking	40	Login	29/35/42
Anti-legionellae	41	M alfunction	30 ff.
Antifreeze	40	Manual mode	42
Auxiliary heating	16/28/40	Message list	26/29
B oiler control functions	16	O peration of the controller	11
Break-out segments	10/15	Output parameter	38
C able cross sections	8	P rofessional mode	35 ff.
Cable diameter	15	Protective functions	28/40
Cleaning	6	PWM control signal	23
Collector cooling	39	R otary encoder	10
Commissioning mode	21	S ensor line	6
Connection	16	Service wizard	31 ff.
Contrast	27	Scope of Supplies	8
D ate/Time	21/27	Software version	29
Description	6	Strain relief device	10/15
Disposal	44	T ank cooling	29/41
E mergency OFF	42	Temperature sensor	6
Evaluation	25 f./36	Tube collector	28/38
G uided diagnostic process	30 ff.	W all-mounting	14
H E pump	16/23		
Hydraulic systems	18 ff.		

Number	Text on display	Description of error or warning	Activity
M00	No present error found!	For this message, no error was found	none
M01	Sensor short-circuit on TS1!	Sensor short circuit at sensor input TS1	Solar circuit pump can be controlled continuously
M02	Breakage of sensor on TS1!	Sensor breakage at sensor input TS1	
M03	Sensor short-circuit on TS2!	Sensor short circuit at sensor input TS2	
M04	Breakage of sensor on TS2!	Sensor breakage at sensor input TS2	
M05	Sensor short-circuit on TS3!	Sensor short circuit at sensor input TS3	
M06	Breakage of sensor on TS3!	Sensor breakage at sensor input TS3	
M09	dT bet. coll. and Storage to high	The temperature differential between the collector and lower accumulator sensor has exceeded the limit value for an extended period	
M10	dT bet coll. and repeatedly too high	See error M09, but error has occurred repeatedly	
M11	dT to yield sensor too high!	The temperature differential between the solar flow and return flow during controlled operation of the solar circuit pump has exceeded the limit value for an extended period (see parameters in menu 1.6.2)	
M12	dT to yield sensor repeatedly too high	See error M11, but error has occurred repeatedly	
M13	High solar T while pump does not run!	The temperature differential between the solar flow and return flow while the solar circuit pump was stopped has exceeded the limit value for an extended period (see parameters in menu 1.6.2)	
M14	High solar T repeatedly while pump does not run!	See error M13, but error has occurred repeatedly	

Number	Text on display	Description of error or warning	Activity
M32	Check date and time	Invalid values were entered for the time and date. New values have to be entered; reason: overly long voltage interruption.	none
M35	Checksum error in Flash parameters	in the parameter memory area, a bit error has been detected, factory setting for the parameters is reloaded.	yes, see on the left
M36	Zero Crossing detection failure!	zero voltage detection of the mains voltage is no longer possible, internal error.	none
W66	Collector Cooling	"Collector cooling" safety function is active	Solar pump is on
W67	Collector Emergency Switch-Off	"Collector emergency stop" safety function is active	Solar pump is off
W68	Tank limit temperature exceeded	"Accumulator limit temperature" safety function is active	Solar pump is off
W69	Frost protection triggered	"Frost protection" safety function is active	Solar pump is on

Edition BE 07/2016
0157 - 31NPT2S2U2G2AT3-C

